

**Favolite**

**Vader Profile 700II**

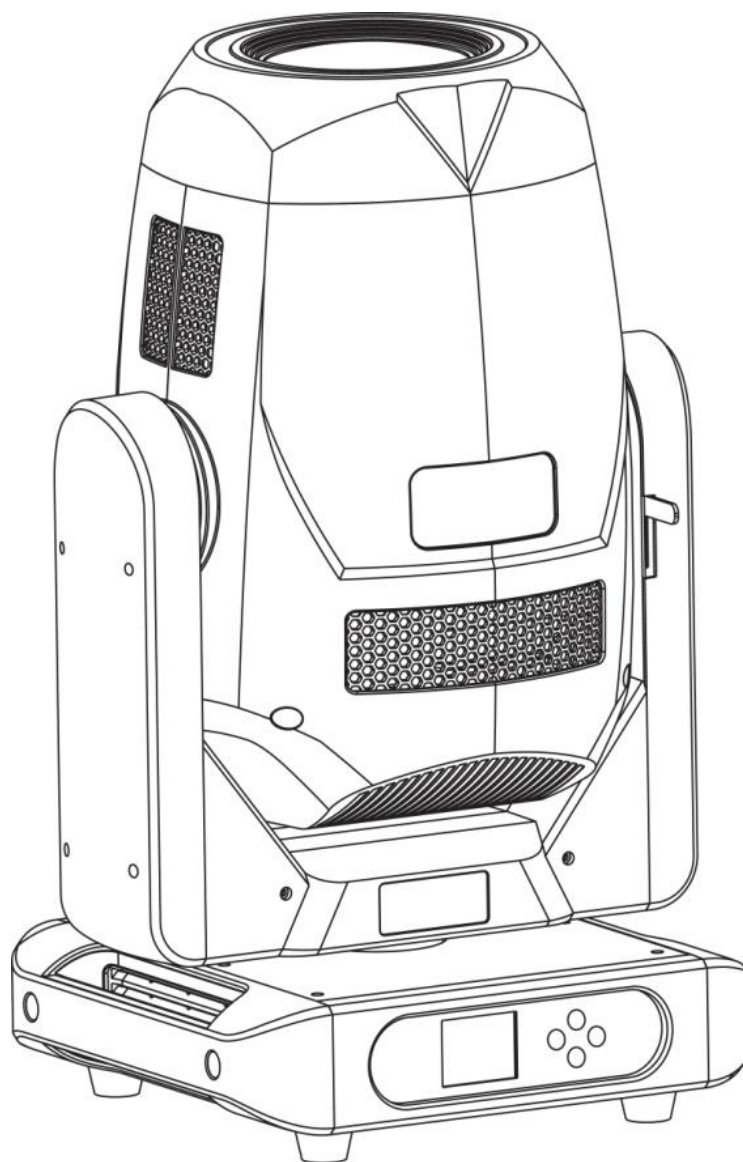

# Manual

Version: 900700001-1.0.0

# CONTENTS

1 Safety Guide.....	1
2 Quick Start.....	4
2.1 Unpacking and Visual Inspection.....	4
2.2 Initial Power-On and Self-Test.....	4
2.3 Quick Start (Address Code Setup + Basic DMX Connection).....	5
2.4 Common Issues Quick Reference.....	7
2.5 Safety Precautions.....	7
3 Packing List & Accessories.....	8
3.1 Standard In-box Contents.....	8
3.2 Optional And Compatible Accessories.....	8
4 Technical Specifications.....	10
4.1 Technical Specifications.....	10
4.2 Compliance And Certification (CE/RoHS/IP).....	12
4.3 Operating Environment And Mounting Orientation Restrictions.....	12
5 Lighting Installation.....	14
5.1 Installation Notes.....	14
5.2 Quick-Lock Clamp Installation Steps:.....	15
5.3 Power Connection.....	15
5.4 Power Specifications And Connection Requirements.....	16
5.5 Signal Connection.....	16
6. Controls and Menus.....	27
6.1 Control Panel.....	27
6.3 Menu Function Operation.....	32
6.4 RDM Function.....	39
6.5 FINE ADJUSTMENT.....	39
7 DMX/Network and Channel .....	40
7.1 DMX Basics and Wiring Specifications.....	40
7.2 Network control and cabling specifications.....	40
7.4 Gobo Wheel.....	45
7.5 Network Control.....	46
8 Maintenance & Consumables.....	47

8.1 Lighting Cleaning and Maintenance .....	47
8.2 Gobo Replacement.....	48
8.3 Troubleshooting.....	51
8.4 Error Code Table.....	52
9 Lighting Upgrade and Recovery .....	53
9.1 Supported Upgrade Methods.....	53
9.2 Lighting Upgrade.....	53
9.3 Version Check and Factory Reset.....	56
9.4 Upgrade Notes and Failure Recovery .....	57
10 Appendix.....	58
10.1 Connector Pinouts and Electrical Parameters.....	58
10.2 Fan and Blower Parameters .....	58
11 Warranty & Service .....	59
11.1 Warranty Terms and Limitations.....	59
11.2 After-sales and Technical Support.....	60
12 Environmental Protection and Recycling.....	61
12.1 Materials and Environmental Declaration.....	61
12.2 Recycling and Disposal Guidelines.....	61
13 Declaration.....	61

# 1 Safety Guide



Please install, operate, and maintain this lighting according to the following instructions.

## **WARNING**

Thank you for choosing our lighting. For your safety, please read this manual carefully before installation and operation. This manual contains important information regarding installation and application. Please keep this manual in a safe place for future reference.

## **Attention**

- Products are shipped in complete packaging. Operate strictly according to this manual upon receipt; damage resulting from improper operation is not covered under warranty.
- Inspect immediately after unpacking to verify absence of shipping damage or missing components.
- This lighting is designed for dry, controlled environments. For applications in damp or outdoor conditions, refer to the product's technical specifications (IP rating).
- Installation, commissioning, and maintenance must be performed by qualified professionals.
- Operation by or proximity to minors near operating lighting is strictly prohibited.
- Fixed installation requires certified mounting components and safety cables; disconnect power and support the base during movement.
- Install equipment in well-ventilated locations with sufficient clearance (**minimum 3 meters from nearest combustibles**).
- Maintain unobstructed ventilation openings and heat dissipation paths; avoid prolonged blockage to prevent overheating.
- Verify power supply voltage matches product label specifications before operation; all electrical connections must be completed by qualified electricians.
- Equipment enclosure must be reliably grounded through the protective earthing terminal.
- Operate only within specified ambient temperature ranges (refer to technical parameters); prolonged operation outside rated temperature ranges is prohibited.
- Do not connect lighting directly to external dimmers or phase-dimming circuits.
- Keep flammable materials away from operating area; maintain safe distance to prevent fire hazards.
- Inspect power cords and connectors before each power-on; immediately discontinue use and replace if damage is found.
- The housing reaches high temperatures during operation; do not touch with bare hands. Allow to cool and disconnect power before maintenance.

- Prevent ingress of water, flammable liquids, or metallic objects; immediately disconnect power and contact qualified personnel if contamination occurs.
- Avoid operation in excessively dusty, oily, or corrosive environments; perform regular cleaning and maintenance (disconnect power before maintenance).
- Do not touch cables or power terminals during operation; prevent cable entanglement with other lines.
- **Avoid** direct illumination of flammable or heat-sensitive surfaces at close range (**less than 3 meters**).
- Avoid frequent short-cycle power switching; allow sufficient cooling time before restarting (see maintenance manual).
- If the housing, lens or other components show visible damage, have them replaced or repaired by qualified personnel immediately.
- No user-serviceable parts inside; do not open the housing.
- In case of malfunction, immediately stop operation and disconnect power; arrange for professional inspection and repair.
- Disconnect power and unplug power cord during extended storage or maintenance periods.
- Use original packaging and padding materials for secure transportation.
- Lock X and Y axes and secure all moving parts before shipping.
- Do not look directly at light source during operation; wear protective glasses and maintain safe distance when necessary.
- Do not operate with missing protective covers or damaged housing; arrange for inspection and repair immediately.
- Never expose front lens to direct sunlight or other intense light beams; avoid direct strong light exposure during unpacking, installation, storage and extended idle periods.
- Never direct beam output from one lighting unit into front lens of another lighting unit.

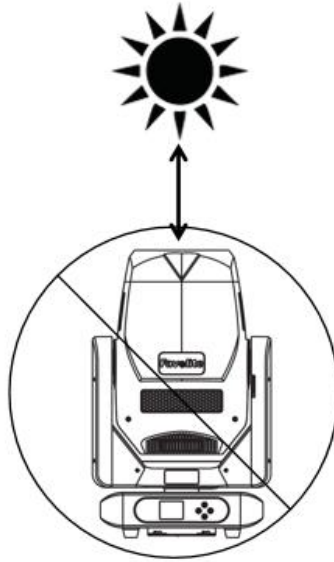

Installation, commissioning, and maintenance must be performed by qualified professionals



Fixed installation requires certified mounting components and safety cables



Install equipment in well-ventilated locations with sufficient clearance



The housing must be reliably grounded through the protective earthing terminal



Keep flammable materials away from operating area; maintain safe distance to prevent fire hazards



Inspect power cords and connectors before each power-on lighting



The housing reaches high temperatures during operation; do not touch with bare hands



Prevent ingress of water, flammable liquids, or metallic objects



Avoid direct illumination of flammable or heat-sensitive surfaces at close range



Do not look directly at light source during operation; wear protective glasses

## 2 Quick Start

Please install, operate, and maintain this lighting according to the following instructions. Purpose: To help you complete inspection, power-on self-test, and basic DMX linkage in the shortest time possible, verifying the lighting functions properly.



(Scan the QR code to view the specific operation steps)

<https://favo-lite.com/lighting-fixture-quick-start-guide/>

### 2.1 Unpacking and Visual Inspection

- Before unpacking: Maintain upright orientation during transport; avoid strong impacts and tilting. Photograph any external packaging damage and notify both carrier and supplier immediately.
- Checklist : Refer to section [3.1 STANDARD IN-BOX CONTENTS](#)
- Visual inspection: Ensure front lens shows no scratches or cracks; ventilation openings are free of obstructions; housing is undamaged; all XLR/RJ45/power connectors are intact with straight pins; serial number and rating plate are clearly legible.
- Transport/maintenance lock: If mechanical locking mechanisms are present, keep them engaged until the lighting is permanently installed to prevent structural damage during movement.
- Environment and power requirements: Operate in dry, well-ventilated environments; use power supply AC 100-240 V, 50/60 Hz with proper grounding connection; never connect to phase-control dimmers or SCR dimmer outputs.

### 2.2 Initial Power-On and Self-Test

- Rigging and safety: Secure the lighting with certified rigging components and install separate safety cable; ensure unobstructed movement range for pan/tilt mechanisms; remove transport locks only after secure installation.

- Power-on self-test: The unit performs automatic self-test upon power connection, including pan/tilt, zoom/focus, color wheel/gobo wheel, and framing system. Typical duration: 40-90 seconds.
- Basic setup (recommended):
- Menu language and display orientation: Set Chinese/English with automatic screen rotation.
- Operation mode: Select Normal/Economy/Silent mode according to application requirements.
- PWM frequency: Adjust based on application; higher PWM frequency recommended for filming applications to avoid rolling stripes.
- DMX channel setting: 16CH (dimming mode, for details refer to "DMX512 channel table").
- Troubleshooting: If error codes appear or mechanisms fail to operate, record the code and phenomenon, then refer to "8.3 Troubleshooting and Error Codes" or contact technical support.

## 2.3 Quick Start (Address Code Setup + Basic DMX Connection)

### Step 1 Select Channel Mode

- This function can be adjusted only after entering the password 1234 via Setting Lock.
- Operation:
- [MODE/ESC] enter Main Menu - User
- [ENTER] enter, select Setting Lock
- Press [ENTER] twice to enter and confirm; a 4-digit password is displayed
- Use [ENTER] to select a digit; after selection, use [UP/DOWN] to scroll to the next digit and continue
- The password is 1234. If incorrect, ERR is displayed
- After completion, press [MODE/ESC] to save.
- Select Channel Mode
- Menu path: Press [MODE/ESC] to enter Main Menu - Basic Info, press [ENTER] to enter, select Channel Mode, press [ENTER] to enter, use [UP/DOWN] to set: 39CH/41CH, press [ENTER] to save.
- Select 39-channel (Standard) or 41-channel (Extended).39CH is recommended for first-time use.

## Step 2 Set DMX Start Address

- Menu path: Press [MODE/ESC] to enter Main Menu - Basic Info, press [ENTER] to enter, select Address, press [ENTER] to enter, use [UP/DOWN] to set: address 1-512, press [ENTER] to save.
- Example: set to 001. When multiple units are daisy-chained, the next unit start address should be:
  - 39CH: previous unit start address + 39 (e.g., 001 → 040 → 079 → 118...)
  - 41CH: previous unit start address + 41 (e.g., 001 → 042 → 083 → 124...)

When using a DMX controller, each lighting fixture must be assigned a DMX start address to ensure that it can correctly receive the corresponding control signal. If the address is set incorrectly, it may cause control anomalies or signal confusion.

You can set the same starting address for all lights or a group of lights, or you can set a different address for each light.

- Same start address: Multiple lights can share the same address, and all lights will respond synchronously. In this case, adjusting the parameters of a channel will affect all lights at the same time.
- Different starting addresses: Assign an independent address to each light. The light will receive signals starting from the set channel number and only respond to its own channel settings without affecting other lights.

For example, if the first fixture is set to 39-channel mode and its DMX start address is 1, the DMX start address of the next fixture should be set to 40.

Because the first fixture occupies channels 1 through 39, the next available channel number is 40.

The following is an example of address code setting when multiple fixtures are connected in series:

Channel Mode	Lighting 1 Address code	Lighting 2 Address code	Lighting 3 Address code	Lighting 4 Address code	Lighting ** Address code
39 Channel	1	40	79	118	.....
41 Channel	1	42	83	124	.....

## Step 3 Connect DMX Signal

- Use a shielded DMX cable to connect the console DMX OUT to the lighting DMX IN; to continue daisy-chaining, connect the lighting DMX OUT to the next DMX IN.
- Insert a 120 Ω terminator at the last unit to improve stability; for a single DMX branch, recommended devices ≤32, bus length ≤300 m.

#### **Step 4 Light-on Test**

- On the console, select the corresponding Universe and start address; raise the Dimmer channel to 100% (see Channel Table for the exact range).
- Use Pan/Tilt to move the lighting, and test basic functions of Zoom/Focus, color wheel, CMY/CTO, fixed/rotating gobo wheels, animation wheel, prism, frost, iris, and the framing module.

#### **Step 5 (Optional) RDM Quick Configuration**

- If the controller supports RDM, after Discover Devices on the controller, write the start address and channel mode directly; upon completion, reset the lighting to apply the settings.

### **2.4 Common Issues Quick Reference**

No response: Check whether start address/channel mode match; confirm Blackout is not active; verify wiring order and terminator.

Flicker/jitter: Add a 120  $\Omega$  terminator at the end; avoid running in parallel with audio cables; if necessary, temporarily disable RDM broadcast on the console for testing.

### **2.5 Safety Precautions**

High-intensity light warning: Do not look directly into the beam; keep a safe distance (**more than 3 meters**) from combustible materials and ensure ventilation clearance.

Use only compliant rigging hardware and an independent safety cable; disconnect power before maintenance.

## 3 Packing List & Accessories

Purpose: This chapter lists the standard in-box contents and optional/compatible accessories to facilitate receipt verification and project selection.

Important Notes: Actual delivery is subject to the in-box packing list; minor variations may exist between batches or regional versions.

### 3.1 Standard In-box Contents

#### Standard configuration (carton packaging) :

- Lighting ×1
- Power Connector Cable/Plug ×1
- Dmx Signal Cable ×1
- Omega ×2
- Safety Cable ×1
- Manual ×1

#### Standard configuration (flight case packaging) :

- Lighting ×1
- Power Connector Cable/Plug ×1
- Dmx Signal Cable ×1
- Omega ×2
- Clamp ×2
- Safety Cable ×1
- Manual ×1

• Optional Configuration Note: When the folding clamp configuration is selected, the omega and clamp from the standard configuration will not be provided (replaced by the folding clamp kit).

### 3.2 Optional And Compatible Accessories

#### Suspension And Quick Mount

- Clamp/omega (spare/add-on): For quick connection to the lighting base; recommended to use with a half coupler.
- Half coupler/clamp (48–51 mm): Fits common truss; select models with sufficient rated load (WLL), and use with a safety cable.

- Quick coupler/quick-release coupler: Supports one-hand fast attaching and detaching, improving setup efficiency.
- Folding clamp (optional): Easy for storage and transport; upon purchase it replaces the standard omega/clamp.

### **Cables And Termination**

- DMX512-A signal cable: Shielded twisted pair, 3-pin or 5-pin XLR (depending on region/model).
- 120  $\Omega$  terminator: Used at the end of each DMX branch to enhance interference immunity and stability.
- Power cable and connectors: AC power cable/connector compatible with the unit's power inlet (select per local standards).

Jumpers and extension cables: For short jumpers and extension cables inside racks or truss.

### **Front Accessories**

- Rain cover: For outdoor weather protection.

### **Transport And Protection**

- Flight case cushioning bumpers: Improve transport safety, but increase transport volume.

### **Safety And Tools**

- Certified safety cable: Rated to match the total lighting weight/installation height; recommended to use products with compliant testing and markings.
- DMX/RDM commissioning tools: RDM controller or USB adapter, for quick addressing and parameter configuration.
- Torque tools and threadlocker: For torque-controlled fastening and anti-loosening maintenance.

### **Compatibility And Precautions**

- Accessory selection shall meet project load, space, and regulatory requirements; the clamp's rated load (WLL) shall be no less than the total lighting weight and comply with the applicable industry safety factor.
- Use shielded DMX cable compliant with DMX512-A; avoid parallel runs with audio cables; use a 120  $\Omega$  terminator at the end.
- The above accessory list covers common optional/compatible items, subject to actual supply and order.

## 4 Technical Specifications

### 4.1 Technical Specifications

Complies with GB7000.1-2015, GB7000.217-2008 standards

#### OPTICS

- Light Source :580W White LED Module
- Lifetime: 50000 Hours
- Lumen: 20500 lm
- Color temperature:
  - CRI: at least 70, CT 6500K
  - CRI: at least 90, CT 7000K

#### MOVEMENT

- Pan movement:540° (16 bit)
- Tilt movement :270° (16 bit)
- Automatic reset function

#### COLORS

- Colors wheel:1+6colors
  - Bi-directional rainbow effect
- Linear CMY+CTO

#### GOBOS

- Fixed gobo wheel: 8 gobos + open
  - Rotating gobo wheel:
    - 6 HD interchangeable gobos +open
  - Rotating Gobo size:Outside-27.9MM
    - Inside-22MM;Thickness-1.1 MM
  - Bidirectional variable rotation, Index functions
    - Bi-directional changeable speed shake effect
    - changeable speed and flow effect
  - Animation Wheel:Unlimited rotation,flow and flame effect
- #### FEATURE
- Prism:1 rotating 4-facet prism (3,8,16,24 facet option)

- Iris: Linear adjustable with macro
- Frost: Linear heavy frost
- Focus: Motorized;AUTO-FOCUS
- Zoom: 6.5°-42°linear adjustment, smooth and fast
- Dimmer: 0-100% linear dimmer
- Strobe: Electronic strobe,0.3-20Times/SEC

#### FRAMING SYSTEM

- Motorized framing system with 4 focal planes
- 4 Blades that move separately
- Smooth, flexible blade movements at variable speed
- Framing system smooth movement and extremely accurate position
- Single blade full blackout
- Framing system indexable over 180°

#### CONTROL AND PROGRAMMING

- Standard mode: 39/41 channels
- Fan mode:
  - AUTO/FAST/LOW/SUPER LOW
- Control mode: DMX512, Protocols RDM
  - Wireless DMX and Art-Net
- DMX and RDM data in/out

#### OTHER FUNCTION

- 2.4inch color LCD screen
- High reliability touch button
- Support auto flip display
- Support Multi-language

- Automatic monitoring of light source temperature high temperature automatic protection
- Intelligent cooling system
- DMX512 Software update
- Display light use time
- Low level linearity, flicker free film TV
- Menu setting by internal rechargeable battery without power supply (3.7V rechargeable lithium-ion battery)

- Intelligent control of wind speed
- Reverse display
- Control panel lock
- Manual programming

**POWER SUPPLY AND CONNECTIONS**

- Input voltage:100V~240V AC 50/60Hz
- Rate power:800W@220V
- Power socket: power connector input
- DMX and RDM data in/out:  
Locking 3-pin&5-pin XLR, RJ45 in

**HOUSING**

- Environmentally friendly flame retardant material

- High temperature resistant engineering plastics
- Device locking PAN and TILT mechanisms for transportation and maintenance
- Intellectual property rights of appearance and structure design

**IP GRADE**

- IP:20

**DIMENSION**

- Product Size: 395 x 338 x 638 MM  
-15.55"x 13.31"x 25.12"
- Carton size(1in1):750 x 460 x 520 MM  
-29.53"x 18.11"x 20.47"
- Flight case size(1in1): 550 x 470 x 875 MM  
-21.65"x 18.50"x 34.45"
- Flight case size(2in1): 940 x 470 x 870 MM  
-37.01"x 18.50"x 34.25"

**WEIGHT**

- Net weight:25KG

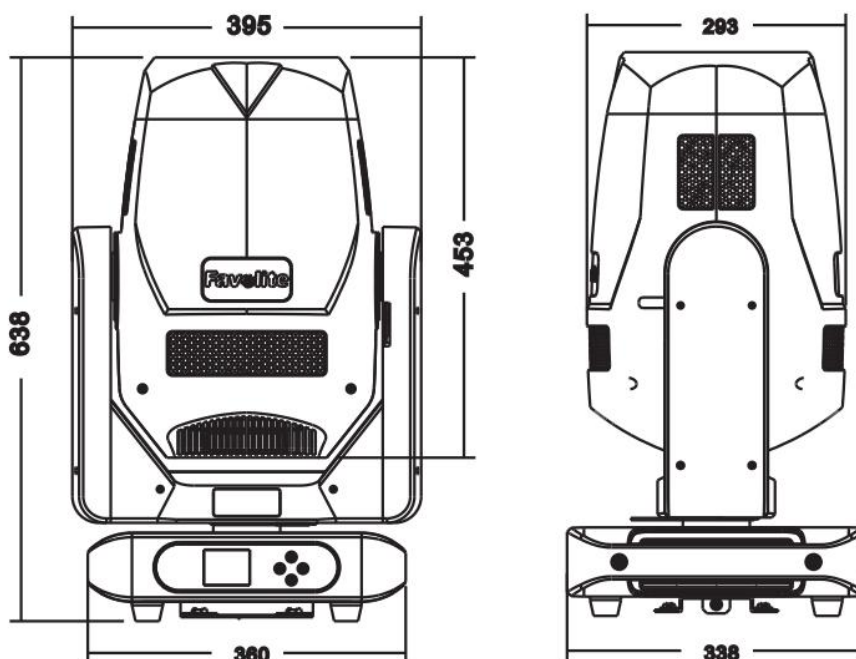

## 4.2 Compliance And Certification (CE/RoHS/IP)

Directive Type	Compliance Standards	Certificate No.	Test Report No.
CE (EMC)	EN IEC 55015:2019+A11:2020, EN IEC 61547:2023, EN IEC 61000-3-2:2019+A1:2021, EN 61000-3-3:2013+A1:2019+A2:2021	OCET240928006EC	OCET240928006EC-Y6
CE (LVD)	EN IEC 60598-1:2021+A11:2022, EN IEC 60598-2-17:2018	OCET240928006SC	OCET240928006SC-S6
RoHS	IEC 62321-1:2013, IEC 62321-4:2013/AMD1:2017, IEC 62321-5:2013, IEC 62321-6:2015, IEC 62321-7-1:2015, IEC 62321-7-2:2017	OCET240928006RS	OCET240928006RS-R6

Ingress protection (IP) rating: IP20 (protected against solid objects  $\geq 12.5$  mm in diameter; not waterproof; for dry environments only)

## 4.3 Operating Environment And Mounting Orientation Restrictions (Operating Temperature, Rigging Angle, Etc.)

To ensure the lighting operates normally and safely, strictly comply with the following operating environment and mounting orientation requirements:

- **Operating ambient temperature:**
  - Permissible ambient temperature (ta):  $-10^{\circ}\text{C} \sim 45^{\circ}\text{C}$
  - Recommended ambient temperature:  $20^{\circ}\text{C} \sim 35^{\circ}\text{C}$

- When the ambient temperature approaches the upper limit, ensure adequate heat dissipation and good ventilation to extend the lifetime of the LED light source and electronic components.
  
- **Storage and transport environment**
  - Storage temperature range: -10°C ~ 50°C
  - Keep the transport and storage environment dry, and avoid severe vibration and shock.
  
- **Ingress protection (IP) and use locations**
  - Ingress protection (IP) rating: IP20
  - For dry environments only; do not use in rain, humid, or high-dust environments.
  - Do not operate in environments with flammable, explosive, or strongly corrosive gases.
  
- **Mounting orientation and angle limits**
  - Supports suspended, horizontal, or upright installation.
  - Maximum safe mounting angle:  $\pm 90^\circ$  (relative to the vertical position).
  - The lighting must be secured using the supplied clamp and simultaneously protected with a safety rope for secondary protection.
  - Maintain at least 0.5 m clearance between the ventilation openings around the lighting and any obstacles during installation.
  
- **Other usage restrictions**
  - Avoid strong vibration or frequent movement.
  - Do not obstruct the light output aperture or any cooling channels.
  - For prolonged use in high-temperature or poorly ventilated environments, add external ventilation or air-conditioning to assist heat dissipation.

# 5 Lighting Installation

## 5.1 Installation Notes

- **Professional Installation Requirements**

The lighting must be installed, removed, and maintained by experienced professionals. Avoid installing the lighting above walkways, rest areas, or any area accessible to unauthorized persons.

- **Position and Method**

The lighting can operate normally in three positions:

Reverse hanging on a truss

Horizontal mounting on a truss

Placed on a flat, level surface

Note: Do not stand directly under the lighting during installation, removal, or maintenance!

- **Structure and Load**

The mounting structure must support a load not less than 10 times the lighting

weight without deformation. Use rated slings and mounting accessories to ensure load capacity and reliability.

- **Safety Cable**

A safety cable rated to at least 12 times the lighting weight is required during installation as secondary protection in the event of lighting failure.

A safety cable attachment point is provided at the bottom of the lighting. Use only the manufacturer-specified safety cable.

- **Safety Inspection**

Inspect all mounting accessories and the lighting regularly to prevent equipment drop or personal injury due to loosening or wear. Improper installation may cause serious personal injury and property damage. Do not operate without proper installation qualifications.

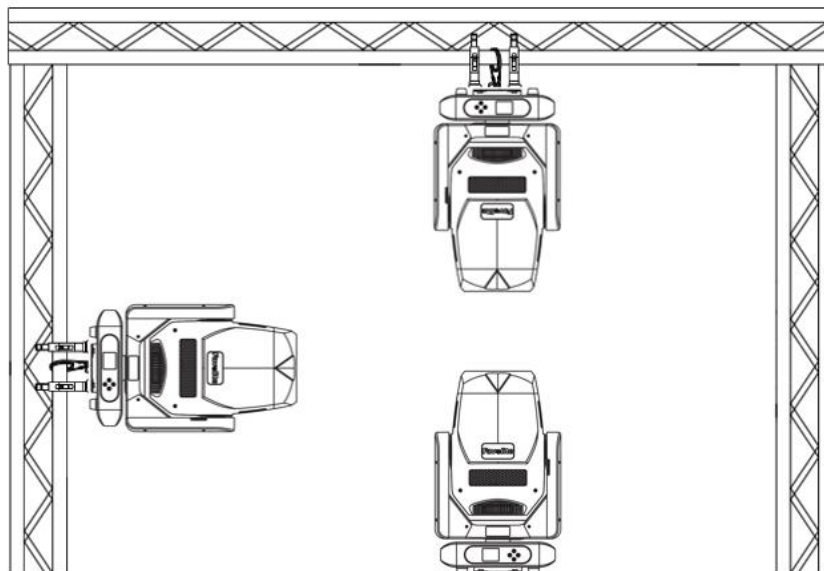

## 5.2 Quick-Lock Clamp Installation Steps:

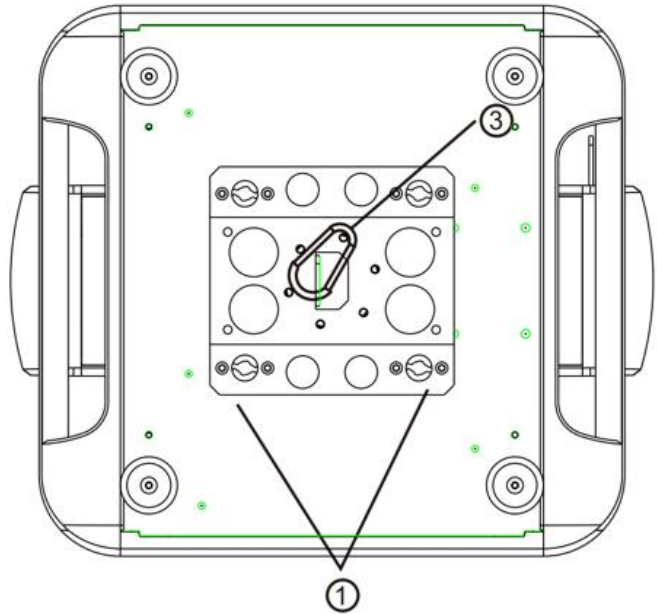
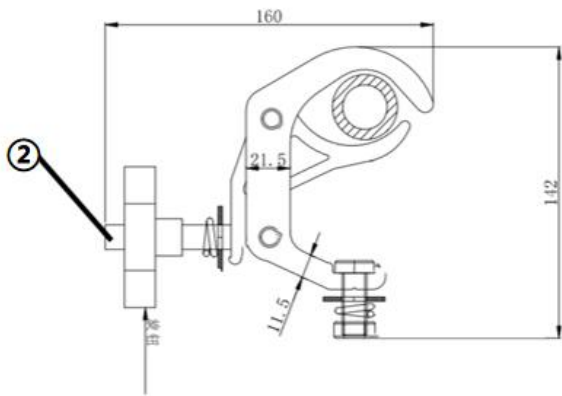

- ① OMEGAHOLDERS
- ② CLAMP
- ③ SAFETY-ROPE
- ④ QUICK LOCK FASTENC

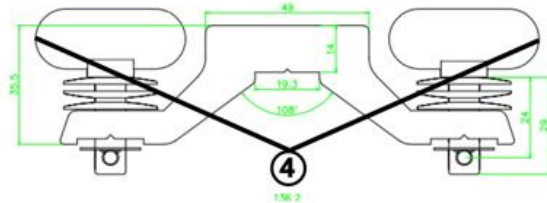

## 5.3 Power Connection



### Power Connection Safety Notes

#### 1. Checks before energizing

- Confirm the X/Y axis locks are fully released.
- Before connecting or disconnecting the power cable or signal cable, ensure plugs and sockets are dry and clean. If moisture or dust is present, clean first.

#### 2. Power Requirements

- Applicable power supply: 90–240V, 50/60Hz
- Max power consumption: 800W
- Must be reliably grounded and isolatable from the AC mains.

#### 3. Installation Requirements

- All wiring and terminations must be performed by a qualified electrician.
- Refer to the diagram below for power cable color coding.

#### 4. Prohibited Operation

- Do not connect this lighting to legacy silicon dimmer packs; equipment damage may occur.

#### 5. Safety Standards:

- Actual installation must comply with local electrical codes.

- Aged wiring may not meet current standards (testing recommended).

Wire Color	Plug	Marking
Brown	Live	L
Blue	Neutral	N
Yellow/Green	Earth	

## 5.4 Power Specifications And Connection Requirements

- Input voltage/frequency: 90-240 V~, 50/60 Hz
- Power factor: PF  $\geq$  0.95 (full load)
- Power connector: Power CON TRUE1 in (16 A)
- Protection class: Class I (PE required)
- Environmental limits: IP20, Ta = 45°C
- Cable and wire gauge recommendation: 2.5 mm<sup>2</sup> / AWG 14, maximum jumper length 30 m

## 5.5 Signal Connection

### • DMX Control and Connection

- Connect the supplied XLR cable between the console and the lighting's 3-pin/5-pin female XLR (DMX IN). Then connect the male XLR (DMX OUT) to the next lighting's female XLR (DMX IN); multiple lighting can be daisy-chained.
- When multiple moving head lighting are daisy-chained, use signal cables with XLR connectors on both ends.
- The DMX address can be any value between 001 and 512.
- The device DMX IN and DMX OUT use 3-pin or 5-pin XLR connectors. Pin 1: Ground, Pin 2: Data-, Pin 3: Data+.

See the figure: DMX512 signal connection.

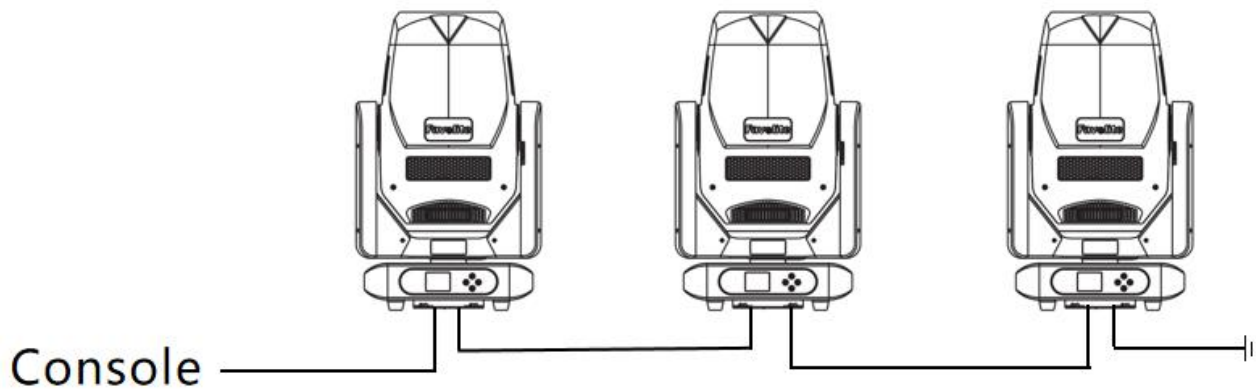

• **Note**

- It is recommended to insert a terminator plug into the DMX OUT of the last lighting (use only on the last lighting).
- The terminator plug is made by connecting a 120Ω resistor across signal (-) and signal (+) (Pin 2 and Pin 3) of a 3-pin or 5-pin XLR plug, then inserting it into the DMX OUT of the last lighting. When using a 5-pin XLR, Pins 4 and 5 are not connected.
- If you are using a standard console, the console's DMX OUT can be connected directly to the first lighting's DMX IN using a DMX cable.
- If interconnection between 3-pin and 5-pin is required, use an adapter cable with correctly matched pin assignments to ensure consistent polarity.

DMX output & XLR connector

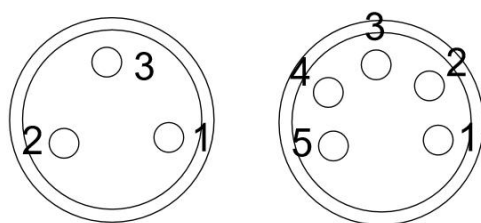

- 1-Ground
- 2-Shield(-)
- 3-Shield(+)
- 4-Not connected
- 5-Not connected

DMX input & XLR connector

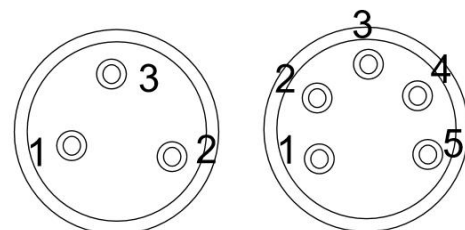

- 1-Ground
- 2-Shield(-)
- 3-Shield(+)
- 4-Not connected
- 5-Not connected

- **DMX Terminator Plug:** In controller mode, the DMX OUT of the last lighting must be connected with a DMX terminator plug. The terminator plug connects an approximately 120Ω resistor between Pin 2 and Pin 3 of an XLR plug (as shown in the figure). Insert this terminator plug into the DMX OUT of the last lighting to effectively avoid noise and reflections during DMX512 signal transmission.



- If the DMX signal cable runs over a long distance or in an environment with electrical noise (e.g., a disco), it is recommended to use a terminator plug. This helps prevent data control signals from interference caused by electrical noise.

### ● Tips

- A device' s signal cannot be connected to two inputs or two outputs; only one IN and one OUT are allowed.
- Do not split by using two outputs. To branch a continuous daisy chain, use a DMX512 signal amplifier.
- Use shielded twisted-pair cable specified for DMX512; standard microphone cable cannot reliably carry long-distance data.

### ● Wireless Transmission

- Optional lighting with wireless transmission can be purchased. Within a wireless signal radius of less than 225 m in open environments, no cabling is required for data transmission; set the corresponding address code to control the lighting effectively.
- The lighting wireless link operates on the 2.4 GHz global ISM band (license-free) with multiple frequency points available.

### ● Operation Procedure

1. Connect the wireless transmitter and lighting console, turn on the power.
2. Turn on the power of the light fixture and wait for the fixture to enter the working state.
3. If the fixture has been connected to other transmitters, perform the following steps first to disconnect the previously connected transmitters. If there is no connection, skip to the next step. You can do this step first no matter if you have connected or not.

● **WIRELESS SET**

1. Enter the menu item WIRELESS SET

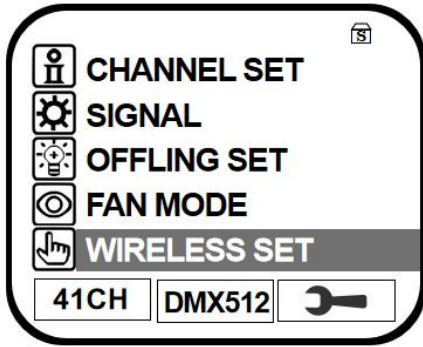

2. Enter, select DISCONNECT and press ENTER. After waiting for 3 seconds, DISCONNECT will disappear, indicating successful disconnection

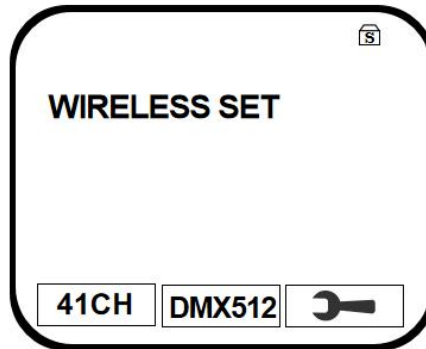
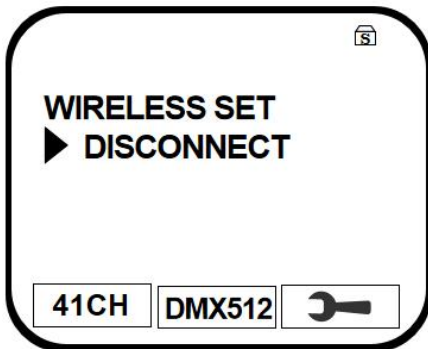

3. SIGNAL: Enter the menu SIGNAL

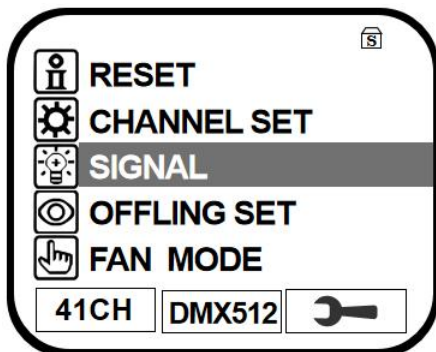

**3. WDMX**

● Press up and down to select WDMX

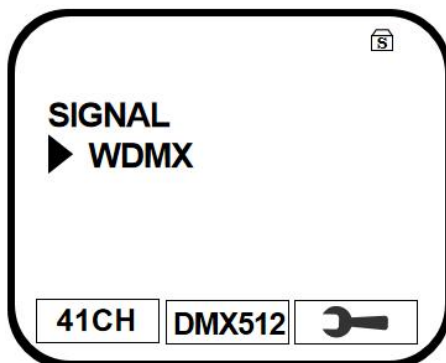

#### 4.PRESS ENTER

This symbol will appear in the upper right corner after success.

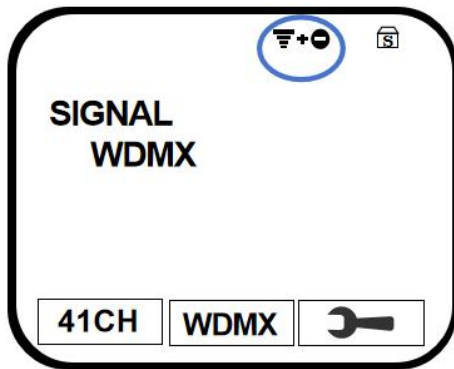

Means that the connection needs to be performed through the button of the transmitter

#### 5.On the transmitter

Press this button for 1 to 2 seconds and wait for the LINK LED to flash.You need to wait from 10 seconds to one minute or more.

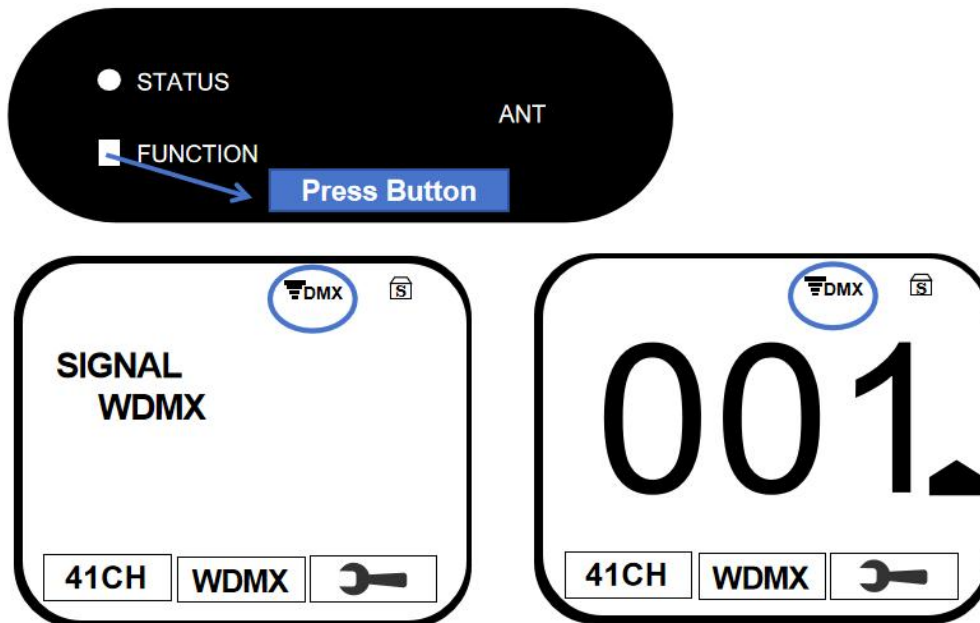

#### 6.This icon appears in the upper right corner

indicating that it has entered the wireless working mode normally

#### Note

- Transmitter placement: keep the antenna as high as possible above obstacles.
- Antenna direction: the front of the transmitting antenna should face the receiving antenna.
- Antenna location: keep as far as possible from interference sources such as WLAN antennas.

- **How to disconnect (Including use the lighting as a transmitter)**

1 By pressing the button of the transmitter for 5 seconds, the LINK LED goes out.

At this time, all fixtures are disconnected from the transmitter.



2 Enter the menu item WIRELESS SET

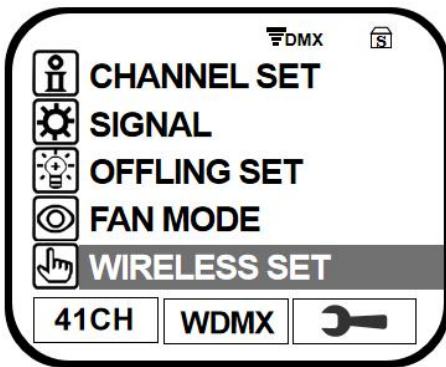

Enter, select DISCONNECT and press ENTER.

After waiting for 3 seconds, DISCONNECT will disappear, indicating successful disconnection.



- **Fixture is used as transmitter.**

Note : the lighting as a transmitter needs a wireless module with transmitting function. And the circuit board version must be 5.51 or above, And requires 9pin connection.

If you need the transmitter function, please consult customer service in advance.

As default, the fixture does not have a transmitting function, even if there is this option in the menu.

When the fixture is used as a wireless transmitter, there is a delay of 0.3 seconds or more.

- 1 Connect the fixture with the console, and wait for them to be ready.
- 2 Enter the menu SIGNAL

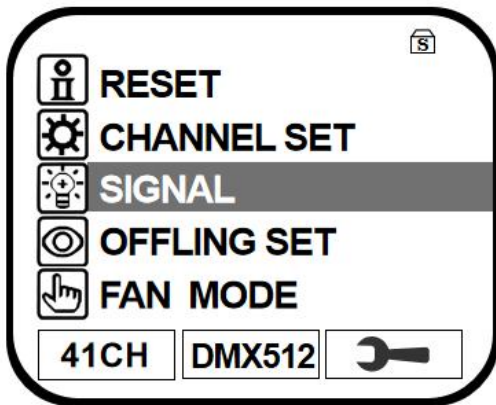

Press up and down to select DMX->WDMX

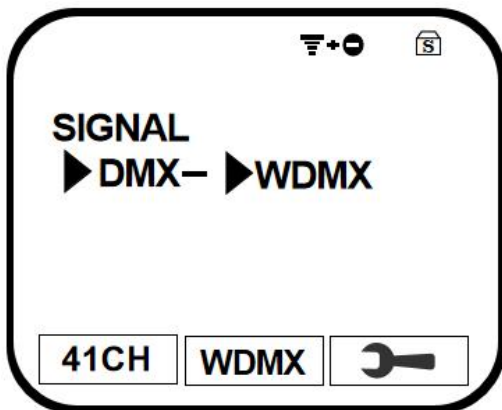

Press ENTER. There is an icon in the upper right corner after success (when the console has a signal)



3 As a transmitter, Linking receivers

WIRELESS SET

Enter the menu item WIRELESS SET

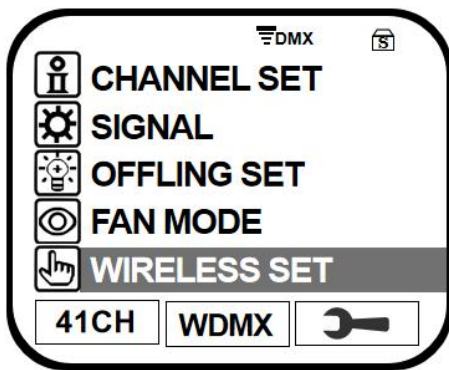

Press up and down, select SEARCH RECEIVER, press ENTER



Wait for the icon in the upper right corner to return to normal

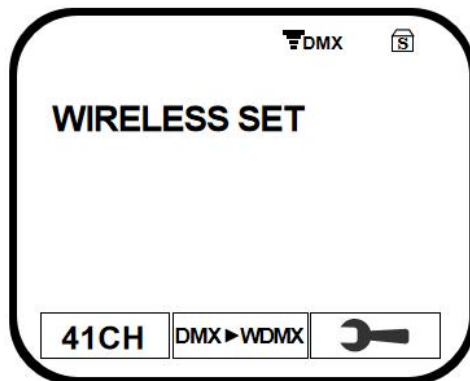

4 As a transmitter, disconnect all receivers. See description in “How to disconnect (Including as a transmitter)” .

If there is no console signal, the following icon will appear after 10 seconds



(Scan the QR code to view the specific operation steps)

<https://favo-lite.com/wireless-sending-operation/>

• **ETHERNET Connection:**

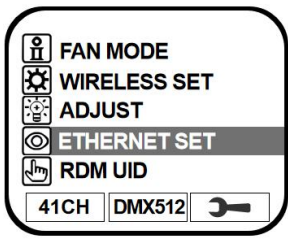
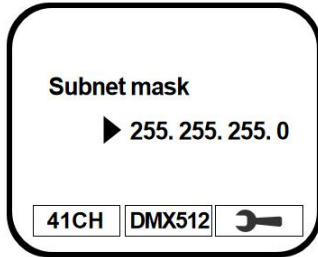
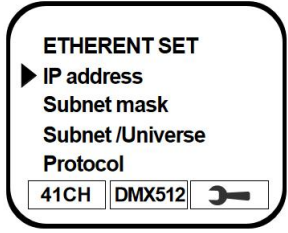
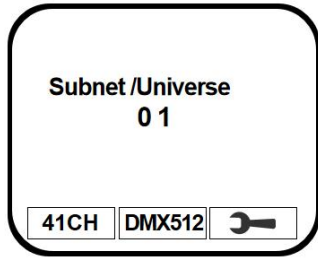
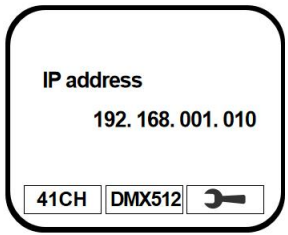
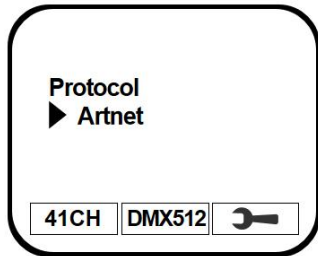
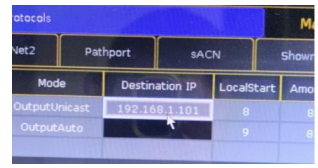
NO.	Function	Figure	NO.	功能 Function	Figure
1	From the menu, select ETHERNET SET		4	Configure the IP addressing this way; the console is configured the same.	
2	Select IP address		5	Configure according to the console settings. The first number is Subnet, the second number is Universe.	
3	Recommended: set the first three IP address numbers the same as the console, and set the last number different.		6	Artnet or sACN, set according to the console.	 

- **Ethernet/DMX512 Connection**

1. Lighting fully controlled via Ethernet:

- Lighting settings: Signal mode select Artnet.
- Ethernet settings: IP address, Subnet mask, UNIVEROUS, set according to the console; network protocol select Artnet.

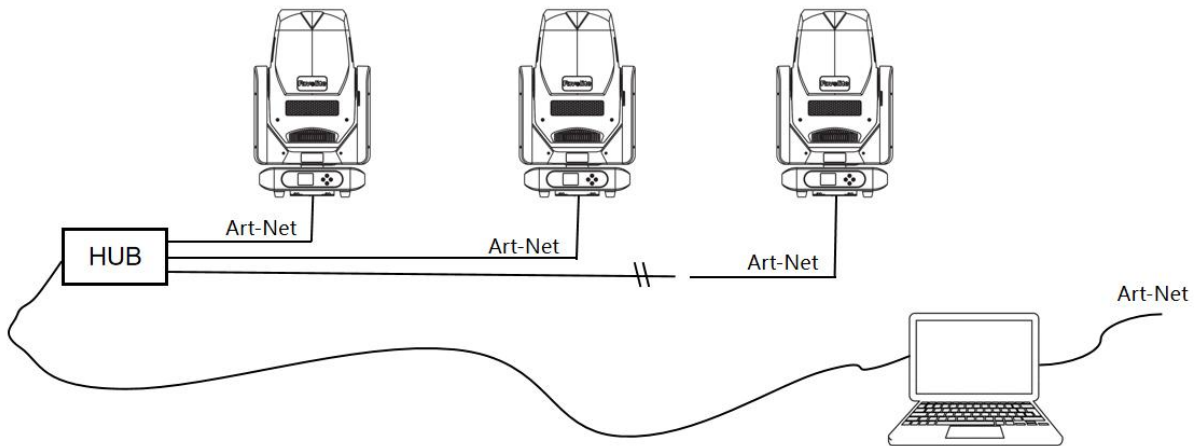

2. Lighting controlled by Ethernet-to-DMX:

- Set the receive mode of the first lighting connected to Ethernet to "Network→DMX" , and set the receive mode of the other lighting to "DMX" . Connect the Ethernet input of the first lighting to the network, then connect its DMX OUT to the next lighting' s DMX IN, continuing in sequence until all lighting are connected to the DMX chain, as shown in the figure.

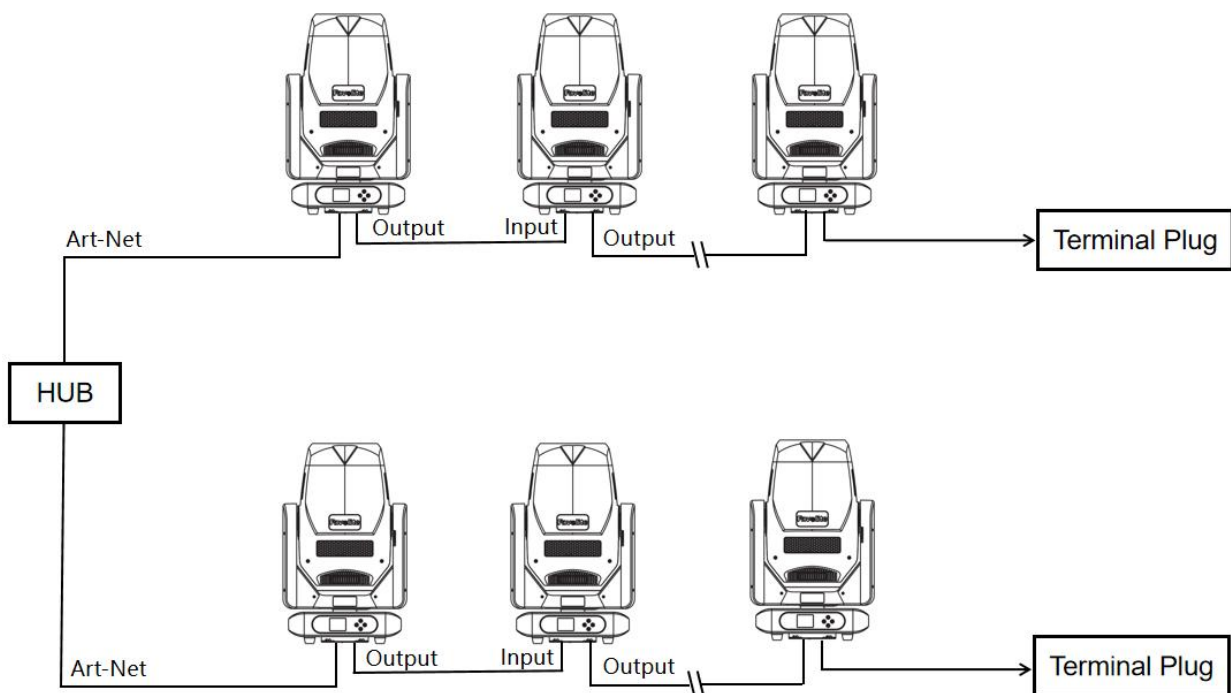

## 6.Controls and Menus

### 6.1 Control Panel



No.	PART	FUNCTION
1	MODE/ESC	Enter Menu/Exit
2	UP	Up and down selection buttons
3	DOWN	Up and down selection buttons
4	ENTER	Confirm selected function
5	BATTERY	<ul style="list-style-type: none"> <li>● Press and hold for 5-7 seconds to power on (when battery has sufficient charge) for menu configuration</li> <li>● All menus except "Reset" and "Device Test" can be accessed/viewed with adequate battery power</li> <li>● Display auto-off after 30 seconds of inactivity</li> <li>● Must use specified battery: 7# 3.7V rechargeable lithium-ion</li> <li>● Automatic charging when fixture is powered</li> <li>● Battery may remain installed during prolonged storage</li> <li>● For air/sea shipment with battery: Declare properly and comply with transportation regulations</li> <li>● Ships without battery unless specified</li> </ul>
6	DISPLAY	Menu Display
7	FUSE	Installing the fuse
8	POWER INPUT	Connecting to the power supply
9	Art-Net IN	Connect to Art-Net
10	WIRELESS	Wireless
11	5-PIN DMX IN	DMX512 IN (5-PIN XLR)
12	5-PIN DMX OUT	DMX512 OUT (5-PIN XLR) - Connect to next fixture for signal output
13	3-PIN DMX IN	DMX512 IN (3-PIN XLR)
14	3-PIN DMX OUT	DMX512 OUT (3-PIN XLR) - Connect to next fixture for signal output

## 6.2 Main Functions of the Menu

### Basic Operation

- **[MODE/ESC]** to enter the main menu.
- **[ENTER]**, **[UP]**, and **[DOWN]** to navigate through the menu.
- To select a menu option or confirm the chosen setting, use **[ENTER]**.
- To return to the previous menu without making any changes, use **[MODE/ESC]**.

Main Menu	Sub-menu	Menu Item	Sub Item
INFORMATION	ADDRESS	001-512	
	RUNTIME	LIGHTING TIME	
	VERSION		
	TEMPERATURE	MAIN BOARD, LIGHT SOURCE	
	FAN SPEED	F1,F2,G1,H2,L3	
	ERROR MESSAGE		
SETTING	RESET	REBOOT	
		DEFAULT DATA	
	CHANNEL SET	39	
		41	
	SIGNAL	DMX512	
		WDMX	
		ETHERNET	
		WDMX-DMX	
		ETHERNET-DMX	
		DMX-WDMX	
	OFFLINE SET	ETHERNET-WDMX	
		HOME	
		HOLD	

Main Menu	Sub-menu	Menu Item	Sub Item	
	FAN MODE	AUTO		
		FAST		
		LOW		
		SUPER LOW		
	WIRELESS SET	DISCONNECT		
		SEARCH RECEIVER		
	ADJUST	PAN		PAN RESET
				PAN Initial mode
				PAN ADJ
				PAN REVERSE: ON/OFF
		TILT		TILT RESET
				TILT ADJ
				TILT REVERSE: ON/OFF
		COLOUR1		COLOUR1 RST
				COLOUR1 ADJ
		GOBO1		GOBO1 RST
				GOBO1 ADJ
		GOBO2		GOBO2 RST
				GOBO2 ADJ
				GOBOR ADJ
		PRISM		PRISM RST
				PRISM ADJ
				PRISM ROTA ADJ
PRISM2			PRISM2 RST	
			PRISM2 ADJ	

Main Menu	Sub-menu	Menu Item	Sub Item
			PRISM2 ROTA ADJ
		ZOOM	ZOOM RST
			ZOOM ADJ
		FOCUS	FOCUS RST
			FOCUS ADJ
		IRIS	IRIS RST
			IRIS ADJ
		FOG	FOG RST
			FOG ADJ
		CMY CTO	CMY CTO RST
			ZERO POINT
			CTO ADJ
			Yellow ADJ
			Magenta ADJ
			Cyan ADJ
		FRAME	FLAME RST
			FLAME ADJ
		BLADE	BLADE RST
			BLADE1 ADJ
			BLADE2 ADJ
			BLADE3 ADJ
			BLADE4 ADJ
			BLADE5 ADJ
			BLADE6 ADJ
			BLADE7 ADJ

Main Menu	Sub-menu	Menu Item	Sub Item
			BLADE8 ADJ
			BLADE ROTA ADJ
	ARTNET SET	IP ADRESS	
		SUBNET MASK	
		SUBNET/UNIVERSE	
		PROTOCOL	Artnet
			sACN
RDM UID			
FIXTURE	/	/	/
DISPLAY	LANGUAGE	ENGLISH	
		CHINESE	
	BACKLIGHT	ON	
		OFF	
		FLASH	
	REVERSE	ON	
		OFF	
		AUTO	
	USER	SETTING LOCK	"1234"
KEY LOCK		ON	
		OFF	
TEST		TEST ALL FUNCTION	pan,P/T speed, pan fine, tilt, tilt fine, colour, cyan, magenta, yellow, cto, gobo1, gobo2, gobo rotation, dimmer, strobe, dimmer mode, prism, prism rotation, zoom, focus, iris, frost,flame open, flame wheel, frame 1A, frame 1B, frame 2A, frame 2B, frame 3A, frame 3B, frame 4A,

Main Menu	Sub-menu	Menu Item	Sub Item
			frame 4B, frame angle, frame macro
		DMX VALUE	001-255
		MACRO	
	PROGRAM	SELECT PROGRAM	1-8
		EDIT PROGRAM	

### 6.3 Menu Function Operation

Function	Specific Operation	Remarks
Address	<p>-[MODE/ESC]-Menu-[INFOMATION]</p> <p>-[ENTER]-Menu-[ADDRESS]</p> <p>-[ENTER]-[UP/DOWN]Setting: Address code 001-512</p> <p>-[ENTER] Save.</p> <p>Quick Actions:</p> <p>Prerequisite: On the address code interface (without entering Menu), e.g., 001</p> <p>-Long press [UP] or [DOWN] for 1-3 seconds to select address code 001-512</p> <p>-[ENTER] to save.</p>	
RUNTIME	<p>-[MODE/ESC]-Menu-[INFOMATION]</p> <p>-[ENTER]-select[RUNNING TIME]</p> <p>-[ENTER]-check the running time of the lighting.</p>	
VERSION	<p>-[MODE/ESC]-Menu-[INFOMATION]</p> <p>-[ENTER]-select[VERSION]</p> <p>-[ENTER]-[UP/DOWN]to turn pages: check the version of the lighting.</p>	
TEMPERTURE	<p>-[MODE/ESC]-Menu-[INFOMATION]</p> <p>-[ENTER]-select[TEMPERATURE]</p> <p>-[ENTER]</p>	

Function	Specific Operation	Remarks
	check the temperature of the main board and light source.	
FAN SPEED	-[MODE/ESC]-Menu-[INFOMATION] -[ENTER]-select[FAN SPEED] -[ENTER]: The fan speeds for the lighting, blower, and three-way sensor are viewable.	
ERROR MESSAGE	-[MODE/ESC]-Menu-[INFOMATION] -[ENTER]-select[ERROR MESSAGE] -[ENTER]: Lighting ERROR MESSAGE can be viewed.	
RESET	-[MODE/ESC]-Menu-[SETTING] -[ENTER]-select[RESET] -[ENTER] twice to enter and confirm -[UP/DOWN] to turn the page: Reboot: Restarts the fixture. Default data: Restores all fixture settings to factory defaults. -After selection, [ENTER] to save.	
CHANNEL SET	-[MODE/ESC]-Menu-[SETTING] -[ENTER]-select[CHANNEL SET] - [ENTER] twice to enter and confirm -[UP/DOWN]to page and select: Channel 39 Channel 41 -After selection, [ENTER] to save.	<ul style="list-style-type: none"> <li>Note: This functions require entering the password "1234" through the "Setting Lock" function before adjusting the value. Please refer to the following related content for the operation of the Setting Lock function.</li> </ul>
SIGNAL	-[MODE/ESC]-Menu-[SETTING] -[ENTER]-select[SIGNAL] -[ENTER] twice to enter and confirm -[UP/DOWN]to page and select:	

Function	Specific Operation	Remarks
	<ul style="list-style-type: none"> <li>● DMX512</li> <li>● WDMX</li> <li>● ETHERNET</li> <li>● WDMX-DMX</li> <li>● ETHERNET-DMX</li> <li>● DMX-WDMX</li> <li>● ETHERNET-WDMX</li> </ul> <p>-After selection, [ENTER] to save.</p>	
OFFLINE SET	<p>-[MODE/ESC]-Menu-[SETTING]  -[ENTER]-select[OFFLINE SET]  -[ENTER] twice to enter and confirm  -[UP/DOWN] to turn the page:</p> <ul style="list-style-type: none"> <li>●Home</li> <li>●Hold</li> </ul> <p>-After selection, [ENTER] to save.</p>	
FAN MODE	<p>-[MODE/ESC]-Menu-[SETTING]  -[ENTER]-select[FAN MODE]  -[ENTER] twice to enter and confirm  -[UP/DOWN] to turn the page:</p> <ul style="list-style-type: none"> <li>●AUTO</li> <li>●FAST</li> <li>●LOW</li> <li>●SUPER LOW</li> </ul> <p>-After selection, [ENTER] to save.</p>	
WIRELESS SET	<p>-[MODE/ESC]-Menu-[SETTING]  -[ENTER]-select[WIRELESS SET]  -[ENTER] twice to enter and confirm  -[UP/DOWN] to turn the page:</p> <p style="padding-left: 20px;">Disconnect</p> <p style="padding-left: 20px;">Search receiver</p> <p>-After selection, [ENTER] to save.</p>	

Function	Specific Operation	Remarks
ADJUST	<p>-[MODE/ESC]-Menu-[SETTING]  -[ENTER]-select[ADJUST]  [ENTER] twice to enter and confirm.  (Taking Pan ADJUST as an example)  -[ENTER]-[UP/DOWN]to page and select:</p> <ul style="list-style-type: none"> <li>●Pan</li> </ul> <p>PAN RESET: rst  Pan ADJ  Pan REVERSE: ON/OFF</p> <p>-After selection, [ENTER] to save.  (Adjustment of TILT, COLOUR1, GOBO1, GOBO2, PRISM, ZOOM, FOCUS, IRIS, FROST, CMY CTO, FLAME, BLADE is the same operation.)</p>	<ul style="list-style-type: none"> <li>● Note: All ADJUST functions require entering the password "1234" through the "Setting Lock" function before adjusting the value. Please refer to Refer to this table in "Setting Lock" section .</li> <li>● For more information, see Section "6.5 FINE ADJUSTMENT"</li> </ul>
ETHERNET SET	<p>-[MODE/ESC]-Menu-[SETTING]  -[ENTER]-select[ETHERNET SET]  -[ENTER]-[UP/DOWN]to page and select:</p> <ul style="list-style-type: none"> <li>● IP: View the lighting's IP address.</li> <li>● Subnet Mask: View lighting's subnet mask.</li> <li>● Subnet/Universe: [ENTER] twice to enter and confirm</li> </ul> <p>[UP/DOWN] to turn the page. After selection  -[ENTER] to save.</p> <ul style="list-style-type: none"> <li>● Protocol: [ENTER] twice to enter and confirm</li> </ul> <p>[UP/DOWN] to turn the page.  After selection  -[ENTER] to save.</p>	
RDM UID	<p>-[MODE/ESC]-Menu-[SETTING]  -[ENTER]- select[RDM UID]  -Press [ENTER] three times to enter, confirm and modify  -[UP/DOWN] for paging: Modify each code.  -After selection, [ENTER] to save.</p>	

Function	Specific Operation	Remarks
LANGUAGE	<p>-[MODE/ESC]-Menu-[DISPLAY]</p> <p>-[ENTER]-select[LANGUAGE]</p> <p>-[ENTER] twice to enter and confirm</p> <p>-[UP/DOWN] to turn the page:</p> <ul style="list-style-type: none"> <li>● Chinese</li> <li>● English</li> </ul> <p>-After selection, [ENTER] to save.</p>	
BACKLIGHT	<p>-[MODE/ESC]-Menu-[DISPLAY]</p> <p>-[ENTER] to enter, select [BACKLIGHT]</p> <p>-[ENTER] twice to enter and confirm</p> <p>-[UP/DOWN]to page and select:</p> <ul style="list-style-type: none"> <li>● ON: Keeps the display always on.</li> <li>● OFF: Keeps the display dark.</li> <li>● FLASH: Flashes to indicate the menu on the display is in active edit mode.</li> </ul> <p>-After selection, press [ENTER] to save.</p>	
REVERSE DISPLAY	<p>-[MODE/ESC]-Menu-[DISPLAY]</p> <p>-[ENTER]-select[REVERSE DISPLAY]</p> <p>-[ENTER]twice to enter and confirm</p> <p>-[UP/DOWN]to page and select:</p> <ul style="list-style-type: none"> <li>● ON: Reverse display; suitable when the lighting is mounted upside down.</li> <li>● OFF: Maintains normal display.</li> <li>● AUTO: Automatically detects the lighting' s mounting orientation using the built-in sensor and switches the menu display orientation.</li> </ul> <p>-After selection, press [ENTER] to save.</p>	
SETTING LOCK	<p>-[MODE/ESC]-Menu-[USER]</p> <p>-[ENTER]-select [SETTING LOCK]</p> <p>-[ENTER] twice to enter and confirm, the 4-digit password is displayed</p> <p>-[ENTER] to select the number, after the selection is completed</p> <p>-[UP/DOWN] to turn the page and select the next number,</p>	

Function	Specific Operation	Remarks
	<p>the password is "1234".</p> <p>-After selection, [ENTER] to save.</p>	
KEY LOCK	<p>-[MODE/ESC]-Menu-[USER]</p> <p>-[ENTER]-[KEY LOCK]</p> <p>-[ENTER] twice to enter and confirm</p> <p>-[UP/DOWN]to page and select:</p> <ul style="list-style-type: none"> <li>● On: Locks the menu keys</li> <li>● Off: Unlocks the menu keys</li> </ul> <p>-After selection, [ENTER] to save.</p>	
TEST	<p>-[MODE/ESC]-Menu-[USER]</p> <p>-[ENTER]-[TEST]</p> <p>-[ENTER]-[UP/DOWN]to page and select:</p> <ul style="list-style-type: none"> <li>● (Functions): Pan, Pan Fine, Tilt, Tilt Fine, Colour, Cyan, Magenta, Yellow, CTO, Gobo1, Gobo2, Gobo Rotation, Dimmer, Strobe, Dimmer Mode, Prism, Prism Rotation, Zoom, Focus, AF Distance, AF Distance Fine, Iris, Frost, Flame Open, Flame Wheel, Frame 1A, Frame 1B, Frame 2A, Frame 2B, Frame 3A, Frame 3B, Frame 4A, Frame 4B, Frame Angle, Frame Macro, P/T Speed</li> <li>● (Value): 001-255</li> <li>● Marco: 000, 255, 170, 128, 043</li> </ul> <p>-After selection, [ENTER] to save.</p>	
PROGRAM	<p>-[MODE/ESC]-Menu-[USER]</p> <p>-[ENTER]-[PROGRAM]</p> <p>-[ENTER]-[UP/DOWN]to page and select:</p> <ul style="list-style-type: none"> <li>● [SELECT PROGRAM]: 1-8</li> <li>● [EDIT PROGRAM]</li> </ul> <p>-[ENTER]-[UP/DOWN]to select each functions:</p> <p>-[ENTER]-[UP/DOWN]-[ENTER]to adjust the values</p> <p>-[MODE/ESC] twice to exit and save.</p> <p>Running PROGRAM:</p> <p>-[MODE/ESC]-Menu-[SETTING]</p>	

Function	Specific Operation	Remarks
	<p>-[ENTER]-select[SIGNAL]</p> <p>-[ENTER] twice to enter and confirm</p> <p>-[UP/DOWN]to page and select [PROGRAM]</p> <p>Please scan and watch the video demonstration:</p>  <p><a href="https://favo-lite.com/manual-programming/">https://favo-lite.com/manual-programming/</a></p>	

## 6.4 RDM Function

Parameter ID	Command Discovery	Command Set	Command Get
DISC UNIQUE BRANCH			
DISC_MUTE			
DISC_UN_MUTE			
DEVICE_INFO			
DMX START ADDRESS		√	
IDENTIFY_DEVICE			
DEVICE_MODEL_DESCRIPTION			
PARAMETER_DESCRIPTION			
MANUFACTURER_LABEL			
DEVICE_LABEL			
DMX_PERSONALITY		√	
DMX PERSONALITY DESCRIPTION			
SLOT_INFO			
SLOT_DESCRIPTION			
SENSOR_DEFINITION			
SENSOR_VALUE			
DEVICE_HOURS			

## 6.5 FINE ADJUSTMENT

### Basic Operation

- Note: All ADJUST functions require entering the password "1234" through the "Setting Lock" function before adjusting the value. Please refer to Refer to this table in "Setting Lock" section .
- [MODE/ESC]-Menu-[SETTING]
- [ENTER]-[UP/DOWN]to page and select Submenu-Adjust
- [ENTER]-[UP/DOWN]to page and select FINE ADJUSTMENT
- After selecting, [ENTER] to save.

**[\\* THE FINE ADJUSTMENT OPERATION ARE DETAILED IN 6.2 OF THIS MANUAL](#)**

## 7 DMX/Network and Channel

### 7.1 DMX Basics and Wiring Specifications

#### DMX512 Connection Guidelines

DMX512 is a digital control protocol based on RS-485 differential signaling. Each Universe supports up to 512 control channels.

Use shielded twisted-pair cable with  $120\Omega$  impedance and standard XLR connectors for all DMX512 connections.

XLR pin out: Pin1 = Ground, Pin2 = Data-, Pin3 = Data+, Pin4/5 = Reserved.

DMX devices must be connected in a daisy-chain topology: Console → Fixture 1 → Fixture 2 → ... → Fixture N. Star or ring topology is not permitted.

A  $120\Omega$  termination resistor must be installed on the DMX OUT connector of the last fixture to prevent signal reflection.

Maximum recommended cable length per run: 300 meters. Maximum number of devices per chain: 32. Use a DMX distributor or signal amplifier for larger systems.

Do not use audio microphone cables as substitutes for dedicated DMX cables.

To prevent signal interference and degradation, keep DMX cables away from high-voltage wiring and strong electromagnetic sources.

### 7.2 Network control and cabling specifications

#### Ethernet-Based Control Protocol (e.g., Art-Net, sACN)

The fixture supports Ethernet-based stage control protocols (e.g., Art-Net, sACN).

Use shielded Cat5e or Cat6 Ethernet cables with standard RJ45 connectors.

Connect using a network switch or a direct point-to-point connection. Avoid using routers or wireless networks (unless explicitly supported).

Star topology is recommended for network wiring, with the control system connected directly to each network node.

Maximum recommended cable length per run: 100 meters. For longer distances, use a Gigabit switch or fiber optic media converter.

Route network cabling separately from DMX512 cabling to prevent electromagnetic interference.

When using multiple network protocols in one system, configure them consistently at the controller to avoid conflicts.

## 7.3 DMX 512 Channel

Channel	Channel	Function	DMX Value	Feature
39CH	41CH			
1	1	Pan	0~255	
2	2	Pan fine	0~255	
3	3	Tilt	0~255	
4	4	Tilt Fine	0~255	
5	5	Colour Wheel	0~7	No Colour
			8~15	Red (RGB Color Model: 255, 0, 0)
			16~23	Yellow (RGB Color Model: 255, 255, 0)
			24~31	Green (RGB Color Model: 0, 255, 0)
			32~39	Cyan (RGB Color Model: 0, 255, 255)
			40~47	Orange (RGB Color Model: 255, 165, 0)
			48~55	Blue (RGB Color Model: 0, 0, 255)
			56~63	No Colour
			64~221	Colour Arbitrary Positioning
			222~239	Rotate Left
			240~255	Rotate Right
6	6	Cyan	0~255	
7	7	Magenta	0~255	
8	8	Yellow	0~255	
9	9	Colour Temperature	0~255	
10	10	Fixed Gobo	0~7	No Gobo
			8~15	Gobo1
			16~23	Gobo2
			24~31	Gobo3
			32~39	Gobo4
			40~47	Gobo5
			48~55	Gobo6
			56~63	Gobo7
			64~71	Gobo8
			72~79	Gobo1 Shake from Slow to Fast
			80~87	Gobo2 Shake from Slow to Fast
			88~95	Gobo3 Shake from Slow to Fast
			96~103	Gobo4 Shake from Slow to Fast
			104~111	Gobo5 Shake from Slow to Fast
			112~119	Gobo6 Shake from Slow to Fast
			120~127	Gobo7 Shake from Slow to Fast
			128~135	Gobo8 Shake from Slow to Fast
			136~143	No Gobo
			144~199	Rotate Left from Fast to Slow
			200~255	Rotate Right from Slow to Fast
11	11	Rotating Gobo	0~7	No Gobo
			8~15	Gobo1
			16~23	Gobo2
			24~31	Gobo3

Channel	Channel	Function	DMX Value	Feature
			32~39	Gobo4
			40~47	Gobo5
			48~55	Gobo6
			56~63	No Gobo
			64~71	Gobo1 Shake from Slow to Fast
			72~79	Gobo2 Shake from Slow to Fast
			80~87	Gobo3 Shake from Slow to Fast
			88~95	Gobo4 Shake from Slow to Fast
			96~103	Gobo5 Shake from Slow to Fast
			104~111	Gobo6 Shake from Slow to Fast
			112~135	No Gobo
			136~195	Rotate Left from Fast to Slow
			196~255	Rotate Right from Slow to Fast
12	12	Gobo Rotation	0~3	No Effect
			4~123	Rotating Gobo Angle
			124~187	Rotate Left
			188~191	Stop
			192~255	Rotate Right
13	13	Dimmer	0~255	
14	14	Dimmer Fine	0~255	
15	15	Strobe	0~3	Open
			4~67	Open<-->Close
			68~99	Close->Open
			100~131	Open->Close
			132~175	Half Open and Half Close
			176~247	Pulse Strobe
			248~251	Synchronous Random Strobe
			252~255	Asynchronous Random Strobe
16	16	Dimmer Mode	0~15	No Effect *1
			16~31	Refresh Rate 1200
			32~47	Refresh Rate 13672
			48~63	Square Law
			64~79	Linear
			80~95	Inverse Square Law
			96~111	S-Curve
			112~223	Reserve
			224~239	Dimmer Auto Fade
			240~255	Dimmer No Fade
17	17	Prism1	0~31	No Prism
			32~255	Prism1 on
18	18	Prism1 Rotation	0~3	Prism is 0
			4~123	Prism Angle
			124~187	Rotate Left
			188~191	Stop
			192~255	Rotate Right

Channel	Channel	Function	DMX Value	Feacture
19	19	Zoom	0~255	
20	20	Zoom Fine	0~255	
21	21	Focus	0~255	
22	22	Focus Fine	0~255	
	23	Auto Focus Distance	0~3	Do not use auto focus
			4~63	5m
			64~127	7.5m
			65~191	10m
			192~255	15m
	24	Auto Focus Distance Fine	0~255	Continuous adjustment within the above distance range
23	25	Iris	0~127	Open to close
			128~135	Close
			136~173	Iris Movement 1
			174~211	Iris Movement 2
			212~249	Iris Movement 3
			250~255	Close
24	26	Frost	0~9	No Effect
			10~255	Liner Frost
25	27	Flame on/off	0~7	No Flame Effect
			8~255	Flame Effect Linear Insertion
26	28	Flame Wheel	0~7	No Effect
			8~127	Rotate Left
			128~135	Rotate Stop
			136~255	Rotate Right
27	29	Frame 1A	0~255	
28	30	Frame 1B	0~255	
29	31	Frame 2A	0~255	
30	32	Frame 2B	0~255	
31	33	Frame 3A	0~255	
32	34	Frame 3B	0~255	
33	35	Frame 4A	0~255	
34	36	Frame 4B	0~255	
35	37	Frame Angle	0~7	No Effect
			8~239	Angle
			240~255	Rotate Left and Right
36	38	Frame Angle Fine	0~255	
37	39	Frame Macro	0~3	No Effect
			4~255	Total 63 Effects(One effect per 4)
38	40	Scan Speed	0~255	Fast to Slow
39	41	Control	0~19	No Used
			20~29	Reset All
			30~39	Reset Pan,Tilt
			40~49	Reset Colour,Gobo,CMY,CTO





Channel	Channel	Function	DMX Value	Feacture
			50~59	Reset Zoom,Focus,Prism,Frost
			60~69	Reset Flame,Iris,Frame
			70~74	Display Default
			75~79	Display Off(don't Keep after shutdown)
			80~84	Display On(don't Keep after shutdown)
			85~89	Fan Speed Low(Keep after shutdown)
			90~94	Fan Speed Medium(Keep after shutdown)
			95~99	Fan Speed High(Keep after shutdown)
			100~104	Fan Speed Super Low(Keep after shutdown)
Please hold the value for more than 8 seconds to take effect,and then return to 0 to avoid repeated activation.				



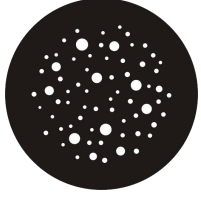

**Gobo Image Download:** <https://www.favo-lite.com/wp-content/uploads/2025/09/Vader-Profile-700II-Gobo.zip>

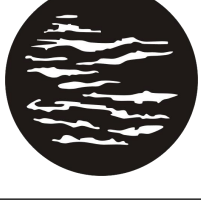
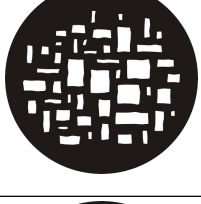
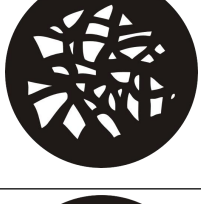
**Gobo Image Download QR Code:**



## 7.4 Gobo Wheel

Vader Profile 700II Fixed Gobo					
No.	Name	Material	Specification	Code	Picture
1	/	High temperature resistant metal	/	/	
2	/	High temperature resistant metal	/	/	
3	/	High temperature resistant metal	/	/	
4	/	High temperature resistant metal	/	/	
5	/	High temperature resistant metal	/	/	
6	/	High temperature resistant metal	/	/	
7	/	High temperature resistant metal	/	/	
8	/	High temperature resistant metal	/	/	

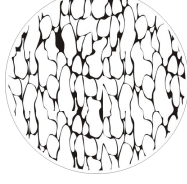
Vader Profile 700II Rotating Gobo					
No.	Name	Material	Specification	Code	Picture
1	PM327	High temperature resistant glass	Φ27.9/22 × 1.1 mm	320700019	
2	PM968	High temperature resistant glass	Φ27.9/22 × 1.1 mm	320700015	
3	PM232	High temperature resistant glass	Φ27.9/22 × 1.1 mm	320700018	
4	PM2341	High temperature resistant glass	Φ27.9/22 × 1.1 mm	321000038	
5	HF1795	High temperature resistant glass	Φ27.9/22 × 1.1 mm	321000039	
6	Diamond Water Ripple	High temperature resistant glass	Φ27.9/22 × 1.1 mm	321000032	

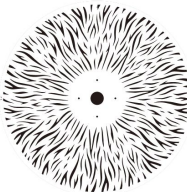
Vader Profile 700II Flame Wheel					
No.	Name	Material	Specification	Code	Picture
1	Flame Wheel	High temperature resistant metal	/	110700054	

## 7.5 Network Control

[\(FOR DETAILS, REFER TO SECTION 5.5 SIGNAL CONNECTION\)](#)

## 8 Maintenance & Consumables

### 8.1 Lighting Cleaning and Maintenance

#### ●Importance

Regular cleaning is essential to extend the service life of the lighting and to maintain optimal performance. Dust, dirt, smoke particles, and haze fluid residues reduce light output and heat dissipation capability.

#### ●Cleaning Frequency

The cleaning interval depends on the actual operating environment and cannot be specified uniformly. The following environments may require more frequent cleaning:

Use of fog or haze machines

Proximity to high airflow areas (such as air-conditioning vents)

Dusty air (stage effects, construction dust, outdoor natural environments, etc.)

After first use, check immediately whether cleaning is required, and establish a periodic inspection and cleaning plan according to actual conditions.

#### ●Cleaning Steps and Precautions

- (1) Operate in a clean, dry, and well-lit environment.
- (2) Disconnect power before cleaning.
- (3) Use a soft, lint-free cloth moistened with clean water or a mild detergent to

wipe gently. Do not use alcohol, solvents, or abrasives.

(4) When cleaning optical components (such as lenses), take special care to avoid scratches or damage.

#### ●Recommended Cycle:

Clean the lens (inside and outside) weekly to prevent dust accumulation and light attenuation.

Clean the fans weekly to maintain effective heat dissipation.

For lighting used frequently, have a professional electrical engineer test the current and circuit contacts every three months to ensure reliable contact and prevent overheating.

#### ●Maintenance Checkpoints:

Ensure all mounting screws are properly tightened; replace any corroded screws promptly.

Confirm no deformation of the lighting body, lens, or bracket.

Verify the rotating head section operates smoothly, with no abnormal wear.

Check that the power cable and insulation are intact and undamaged.

Deeper maintenance (such as structural repair or replacement of electrical components) must be performed by qualified professionals.

## 8.2 Gobo Replacement



### Gobo Replacement and Installation Notes

#### Important Notes

- The original gobo surface has a dedicated high-temperature coating. Custom gobos must match the original in size, structure, material, and quality; otherwise, any resulting damage is not covered under warranty.
- Do not use gobos with double-sided black coating to prevent absorption of heat reflected from the light source or optical components, which will reduce durability.

## Replacement Steps

### 1. Preparation

- Disconnect power to the lighting before replacement and ensure the lighting has cooled.
- Wear clean nitrile gloves to avoid fingerprints and oil contamination on the gobo.
- Prepare appropriate tools (such as a plastic pry bar, tweezers, or needle-nose pliers) to avoid scratching the gobo.
- Use a tool (such as a plastic pry bar) to carefully remove the retaining spring, take out the original gobo, and avoid scratching or contaminating the gobo.

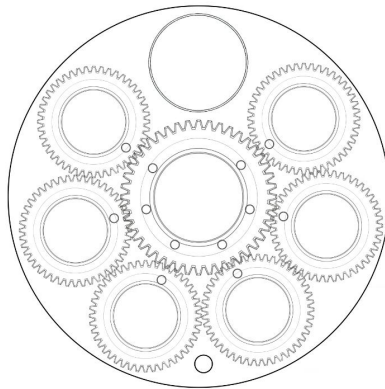

## 2.Remove the Original Gobo

- Rotate the gobo wheel until the alignment marks (arrows) on the gobo wheel and the gobo holder are fully aligned. If necessary, rotate the gobo wheel several times.
- Using tweezers or needle- nose pliers, remove one gobo holder at a time. Note the engagement of the holder tab with the gobo wheel. During installation, ensure the tab is reinserted into its original position.
- Caution: Do not rotate the gobo wheel immediately after removing the holder to prevent orientation misalignment!

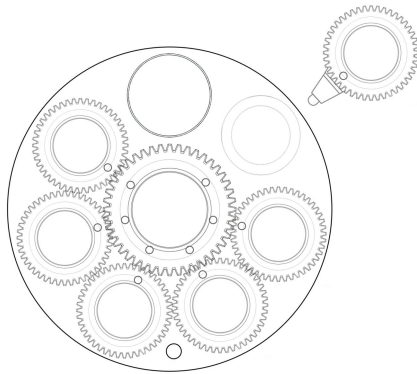

- Use a tool (such as a plastic pry bar) to carefully remove the retaining spring, take out the original gobo, and avoid scratching or contaminating the gobo.

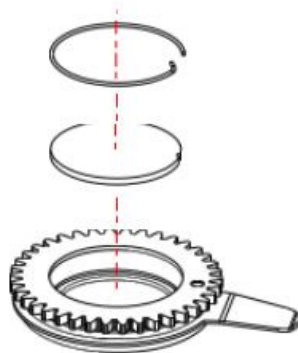

### 3. Install the New Gobo

- Hold the new gobo by its edge. Align the gobo with the alignment mark on the holder (as indicated by the arrow). Ensure the black/textured side faces the front lens, and the reflective/flat side faces the light source.

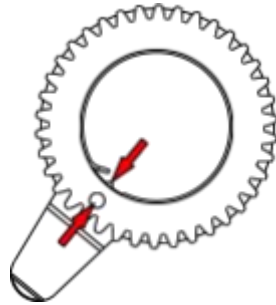

#### How to distinguish the black/textured side and the reflective/flat side

Coated glass gobo	Rippled glass gobo
<p>Black side faces the front lens</p> <p>The other side faces the light source</p>	<p>Smooth side faces the light source</p>
<p>The black side faces the front lens and the other side faces the light source</p>	<p>The smooth side of the rippled glass gobo faces the light source</p>

- Seat the gobo fully into the holder and reinstall the retaining spring flat and even. Ensure the gobo is not loose.
- Insert the holder tab back into its original position on the gobo wheel, and align the alignment marks on the holder and gobo wheel to complete installation.
- After installation, further check that the gobo is securely installed, and power-on lighting to test whether the gobo wheel operates normally.

## 8.3 Troubleshooting

Fault	Potential Cause	Solution
Lighting Not Respond	Lighting not powered on	1.Check if the power is on. 2.Check if the plug is properly inserted. 3.Check if the power cord is correctly connected.
	Switching power supply no output	Replace the switching power supply.
Lighting Shuts Down Unexpectedly	Power cut off	Check the power supply, switch, and circuit breaker.
Light Output Interrupted	Over temperature	1.Check the lighting error messages. 2.Allow the lighting to cool down for a period. 3.Clean the lighting. 4.Reduce the ambient temperature.
Lighting Operation Interrupted	Signal disconnected	Check if the signal line is disconnected.
Abnormal Lighting Operation	Address code or channel mode error	Check and set the correct address code or channel setting.
	Terminator not installed in signal line connection	Install a 120Ω resistor at the end of the signal line.
	Signal line fault	Replace or repair the faulty signal line.
	Faulty lighting interfering with data transmission on the link	1.Trace and isolate the damaged lighting. 2.Arrange for technical personnel to repair the lighting.
Severe Jitter During Pan/Tilt Movement	Pan lock not released Tilt lock not released	Release the lighting pan lock. Release the lighting tilt lock.
	Obstruction in pan position Obstruction in tilt position	Check and remove obstacles affecting normal pan operation. Check and remove obstacles affecting normal tilt operation.
	Magnetic sensor damaged	Replace the magnetic sensor.
	Permanent magnet dropped	Replace the permanent magnet.

## 8.4 Error Code Table



When the light has an abnormality, the error warning will continue to be displayed on the display screen until the fault is eliminated and the warning will disappear.

Error Code	Code Description
EPP	PAN Sensor Error
EPS	PAN Positioning Sensor Error
ETP	TILT Sensor Error
ETS	TILT Positioning Sensor Error
ECL	Color Wheel Motor/Sensor Error
EG1	Fixed Gobo Wheel Motor/Sensor Error
EG2	Rotating Gobo Wheel Motor/Sensor Error
EGR	Rotating Gobo Rotation Error
EP1	PRISM 1 Error
EZM	ZOOM Error
EFC	FOCUS Error
EC	CYAN Error
EM	MAGENTA Error
EY	YELLOW Error
ECT	CTO Motor/Sensor Error
EFA	FRAME Error
EBL	BLADE Error
EF1	LED-FAN Error
ETM	TEMPERATURE Error
EP2	PRISM 2 Error

## 9 Lighting Upgrade and Recovery

### 9.1 Supported Upgrade Methods

- **Supported Methods**
  - Use Favolite Updater to upgrade via signal port (XLR-3/XLR-5).
- **Safety and Compliance**
  - Upgrade should only be performed by professionals.
  - Do not power off or unplug the signal cable during the upgrade process.
  - Multiple lighting units can be connected and upgraded at once (can be daisy-chained via XLR, recommended no more than 6 lighting units).
  - Use original or equivalent cables to ensure secure connections.



### 9.2 Lighting Upgrade

- Preparation
  - Favolite Updater (powered on)
  - Upgrade package corresponding to this model (named and ordered according to engineering model-U×-version number)
  - Signal cable: XLR-3 or XLR-5 (matching the actual interface of the lighting)
- AC Power
  - Disconnect the lighting power and signal cable
  - Instructions for using the Favolite Updater (XLR-3/5) for upgrade: The updater buttons from left to right are Menu, Up, Down, Confirm; the updater indicator light flashing indicates ready/transmitting.
  - Disconnect the lighting power and signal cable.
  - Power on the updater, press any key to enter the main interface.
  - Select the corresponding lighting upgrade directory or file on the updater, press Confirm to enter.
  - Select the first package to upgrade according to the naming order of the upgrade packages (see below). The indicator light starts flashing.
  - Connect the signal cable between the updater and the lighting (XLR-3 or XLR-5, according to the actual interface of the lighting).
  - After the updater indicator light flashes steadily, power on the lighting.
  - After about 10 s, the lighting screen may turn black, which is normal.
  - Press Confirm on the updater to start the upgrade; the updater displays progress, and the lighting screen may flash.

- After a single package is completed, Done is displayed. If there are multiple packages, return to step 3 and complete all packages in order.
- After all updates are completed and the lighting returns to a static state, first turn off and unplug the updater power, then disconnect the signal cable.
- Restart the lighting, and perform version verification according to 9.3 Version Check and Factory Reset.

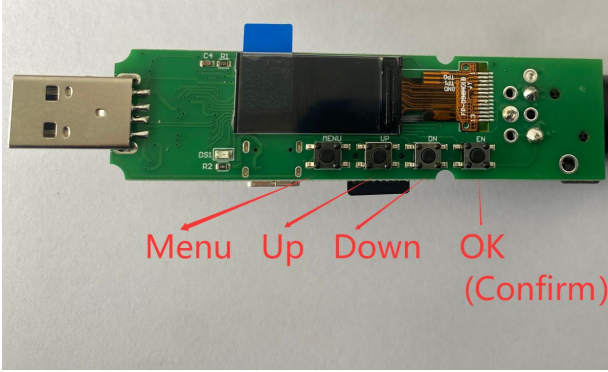
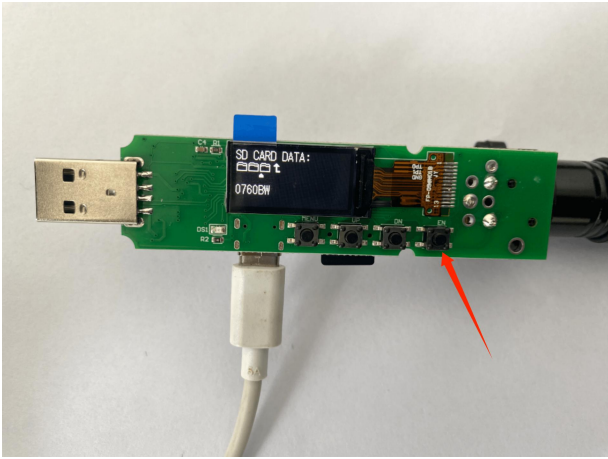
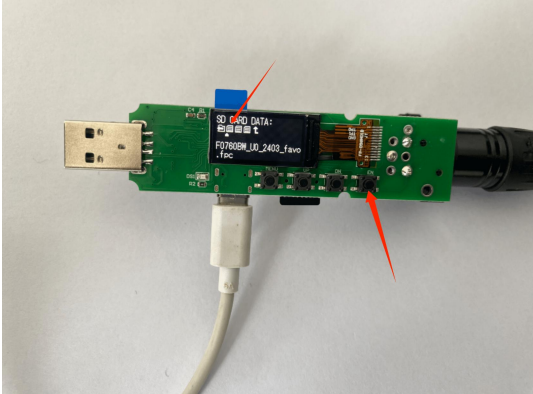
**The specific steps are as follows in the table:**

NO.	Step	Figure
1	<p>1.Connect the power and DMX of the updater (Do not plug in the DMX and power lines for the lighting at this time).</p> <p>1.Press any key to enter the page. (From left to right, 4 buttons: Menu - Up - Down - "OK")</p>	
2	<p>1.Connect the updater to the computer via USB port and copy the latest upgrade files to the root directory of the updater. (If the required upgrade files already exist in the updater, you can skip this step and proceed directly to the next operation)</p> <p>2.Select the file corresponding to the lighting and press "OK".</p>	
3	<p>1.Enter the file, as shown in the picture, there are 3 update documents</p> <p>2.Start updating from the first one, press "OK", and the small light on the updater will flash.</p>	

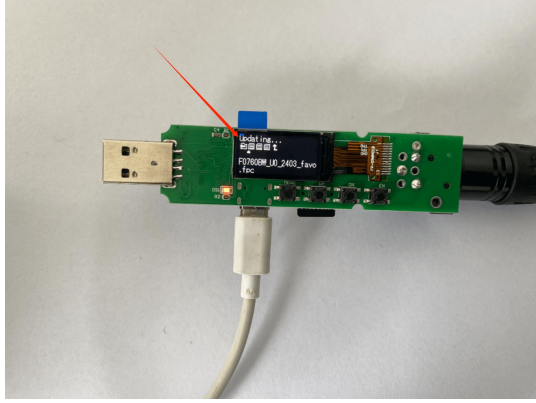
4	Plug in the DMX line on the lighting.	
5	After the updater's small light flashes, then plug in the power on the lighting.	
6	Wait for 10 seconds; the LCD screen turns black.	
7	Press "OK", and it will show that it is updating with a blue progress bar.	

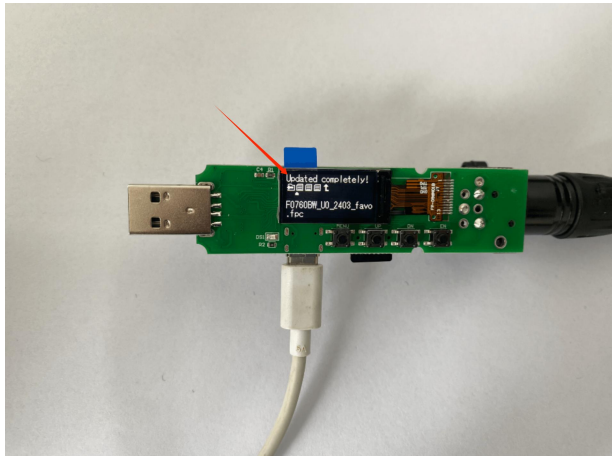
8	During the process, the LCD screen flashes to indicate that it is updating.	
9	<p>1. When one document is updated, the update for that document is complete;</p> <p>2. If there are multiple documents that need to be updated, go back to step 3;</p> <p>3. When all documents are updated, wait until the lighting is stationary and unplug the power supply of the updater.</p>	

\*Note: The figures in this manual are for functional demonstration only and do not represent the actual appearance or model of this product. Refer to the actual product.

- **Naming rule: engineering model number\_U×\_version number**
- Example: F0760BW\_U9\_2401
- Upgrade order: upgrade in ascending U number sequence (U0 → U1 → U3 → ...)  
(Note: numbering is non-linear).
- Note: If only one U package is released this time, update that package only; different version numbers must not be mixed.

### 9.3 Version Check and Factory Reset

- **Version Check**
  - Menu path: Main Menu - Basic Info - Version
  - Confirm that each sub-version (e.g., main control/display/driver) matches the version in the update package.
- **Factory Reset**
  - Menu path: Main Menu (root) > Factory Reset

## 9.4 Upgrade Notes and Failure Recovery

- **Notes**

- Use only update packages matching this model and corresponding hardware version; do not use across models.
- Insert the signal cable and power only after the indicator starts flashing during the upgrade.
- Do not operate other functions of the lighting during the upgrade.

- **Failure Recovery**

- Retry: power off the lighting; keep the updater powered on and select the correct update package; reconnect the signal cable, power on the lighting; press "Enter" to restart the upgrade.
- If multiple retries still fail, the screen remains black, or the menu cannot be accessed, stop cycling power and contact Favolite after-sales service.

- **Information**

- Connector pin type: The unit supports upgrading via XLR-3 or XLR-5 signal ports. Select the corresponding connector pin type and cable according to the lighting's actual configuration.
- If the updater and the lighting pin types do not match, use a compliant adapter cable; do not upgrade via signal splitters/wireless links.

## 10 Appendix

### 10.1 Connector Pin outs and Electrical Parameters

- **DMX Input/Output Connector (XLR 5-pin, compatible with 3-pin)**
  - Pin 1: GND
  - Pin 2: Data-
  - Pin 3: Data+
  - Pin 4: Reserved/Not used
  - Pin 5: Reserved/Not used
- **Ethernet Connector (RJ45, for Art-Net/sACN)**
  - Ethernet connector for Art-Net/sACN
- **Usage Note**
  - Use dedicated signal and power cables complying with industry standards. For operation methods, refer to 4.2 Signal Connection.

### 10.2 Fan and Blower Parameters

Name	Code	V	W	Quantity	Location
Color Wheel Blower	220000003	DC 24V	2.4W	1	Color Wheel
Base Fan	220000010	DC 24V	0.96W	2	Base
Power Supply Fan	220000004	DC 24V	3.12W	1	Base Power Supply
LED Cooling Fan	220000008	DC 24V	2.04W	5	Head LED

## 11.1 Warranty Terms and Limitations

- **After-sales Commitment**
  - Lifetime Maintenance: Favolite provides lifetime maintenance and technical support for this model (within the product's repairable life cycle, spare parts supply is subject to inventory and supply chain).
  - 2-Year Free Spare Parts: Within 24 months from the manufacturing date, for product malfunctions due to non-human causes, required spare parts will be provided free of charge.
- **Warranty Activation Conditions**
  - Purchased from authorized channels with valid proof of purchase; complete and clear serial number; installed and used according to this manual; not modified or disassembled without authorization; usage environment and power conditions comply with specified ranges.
- **Warranty Exclusions**
  - Human damage, misuse/improper installation or wiring, use beyond rated voltage/current, drop/squeeze/transport damage, liquid/chemical intrusion, foreign objects, corrosion, force majeure, etc.;
  - Unauthorized disassembly or modification; altered or missing serial number;
  - Normal performance degradation: such as lumen maintenance rate decrease over time, minor appearance defects not affecting functionality;
  - Issues caused by third-party equipment/software/system compatibility;
  - Malfunctions caused by dust accumulation and poor heat dissipation due to failure to clean as required.
- **Service Scope and Costs**
  - During warranty: Spare parts are free. Shipping, tariffs/taxes, installation or on-site labor are not covered by warranty and will be handled per sales contract or mutual agreement.
  - Out-of-warranty service: Spare parts and repairs provided at standard prices, with quotation provided first and implementation after confirmation.
  - Maximum Liability: Favolite shall not be liable for any indirect, incidental or consequential damages. Our liability is limited to repairing, replacing faulty spare parts, or refunding the spare parts price.
- **Others**
  - If the sales contract or local laws have other mandatory provisions, those shall prevail.

## 11.2 After-sales and Technical Support

- **Serial Number Location:**
  - Lighting Base: Equipped with serial number and bar code.
  - Outer Packaging: Affixed with bar code label corresponding to the lighting.
  - It is recommended to **take photos for records before installation** and provide clear photos when submitting after-sales requests.
  
- **Information Submission:**
  - Official Website: [www.favo-lite.com](http://www.favo-lite.com)
  - Submit questions/suggestions via the Homepage "Up To Our Newsletter Or Suggestions" section, or email [info@favo-lite.com](mailto:info@favo-lite.com), or submit through authorized dealers to create a work order.
  - Required information for work order submission:
    - Product Information: Model (required), Quantity (required), Serial Number (required), Purchase Date and Invoice/Contract Number.
    - Usage Environment: Mains voltage/frequency, installation method, ambient temperature, whether cascaded/using splitters, etc.
    - Phenomenon Description: Specific malfunction performance (required), display information/error codes, reproducibility and occurrence frequency.
    - Checks Performed: Cable/power replacement, factory reset, firmware upgrade, swap tests.
  - Supporting Materials: **Clear photos/short videos** (including serial number label, wiring and malfunction phenomenon).
  - Information Submission: Create work order via official website section, or submit through authorized dealers.
  
- **Remote Diagnosis:** After-sales engineers will respond within 1-2 working days to guide troubleshooting and determine required spare parts/repair methods.
  - Processing Path:
  - Direct Spare Parts Shipment: Corresponding spare parts will be shipped during warranty period.
  - Processing Time: Usually completed within 5-10 working days after receiving spare parts request or returned item, depending on inventory and fault complexity.
  - Completion and Follow-up: Equipment returned or work order closed after repair/replacement completion, with maintenance report and recommendations provided.
  - Data and Privacy: We use your information solely for after-sales purposes and take reasonable protection measures; details available in official privacy policy.

## 12 Environmental Protection and Recycling

### 12.1 Materials and Environmental Declaration

- This product complies with RoHS directive standards, and the materials used are free from hazardous substances such as lead, mercury, cadmium, etc.
- This product is designed with environmental considerations, using recyclable materials to reduce environmental impact.
- During the production process, the use of hazardous substances is strictly controlled to ensure compliance with international environmental standards.
- Product packaging uses environmentally friendly materials and supports recycling.

### 12.2 Recycling and Disposal Guidelines

- This product is electrical and electronic equipment and should be recycled and disposed of according to local regulations.
- Do not dispose of the product with regular household waste; it should be handled by professional recycling agencies.
- During the disposal process, ensure that materials such as batteries, plastics, and metals in the product are properly separated and recycled.
- According to local environmental regulations, select appropriate recycling channels for resource reuse.

## 13 Declaration

This manual may contain errors, omissions, or discrepancies due to product updates. Specifications and functions are subject to change without notice.

We have performed necessary compilation, review, and proofreading processes in accordance with applicable preparation standards and internal quality control requirements. If any discrepancy exists between this manual and the actual product, the actual product shall prevail.

Favolite reserves the right of final interpretation of this manual and the right to revise it without prior notice. Favolite assumes no liability for any direct or indirect losses arising from the use of this manual.

This manual is the full version; the manual supplied with the package is a concise version with simplified content.